

ACK TECHNOLOGIES INC.

MODEL A-30 ALTITUDE DIGITIZER OPERATION MANUAL INSTALLATION MANUAL

MOD 9 GRAY CODE OUTPUT TO 42,000 FEET TWO RS 232 OUTPUTS

MOD 5 GRAY CODE OUTPUT TO 30,750 FEET

Visit www.ackavionics.com for
the latest service bulletins and
installation information before
completing installation.



FAA TSO C-88a
APPROVAL

**THIS MANUAL IS FOR USE
WITH MODEL A-30 ENCODERS
SERIAL NUMBER 120,500 AND
ABOVE (MOD 5 AND ABOVE)**

The conditions and test required for TSO authorization of this article are minimum performance standards. It is the responsibility of those desiring to install the article either on or within a specific type or class of aircraft to determine that the aircraft installation conditions are within the TSO standards.

MANUAL PART NUMBER A30M REVISION 05 10/05/2010

TABLE OF CONTENTS

SECTION 1	DESCRIPTION
SECTION 2	INSTALLATION
SECTION 3	PIN OUT
SECTION 4	RS 232 OUTPUTS
SECTION 5	CALIBRATION
SECTION 6	OPERATION
SECTION 7	CONTINUING AIRWORTHINESS
SECTION 8	SPECIFICATIONS
SECTION 9	PARTS LIST
SECTION 10	TRANSPONDER CONNECTION
SECTION 11	TROUBLE SHOOTING
SECTION 12	WARRANTY

SECTION 1 DESCRIPTION

The model A-30 digitizer is designed to work with all modern mode A/C and mode S transponders. In the mod 4 through mod 7 configuration the digitizer reports to 30,750 feet and provides parallel gray code output. In the mod 8 and above configuration, the digitizer reports to 42,000 feet and provides both parallel gray code and two RS 232 outputs which are jumper selectable in the most popular data formats. RS 232 altitude reporting is jumper selectable in 10 or 100 foot increments. The mod 5 and mod 9 configurations are plug compatible with all earlier mod 1, 2, 3, 4 and 8 digitizers (serial numbers 2,400 through 120,499). Care must be taken when replacing earlier digitizers to make sure that power is only applied to pin 8. See section 8 of this manual before replacing earlier encoders. The cable assembly supplied with the digitizer is tested and complies with all requirements of FAR 23.1359 and FAR 23.853 and is suitable for installation in any part 23 aircraft.

SECTION 2 INSTALLATION

MOUNTING

The Model A-30 digitizer is designed to be located in the same environmental area as the primary altimeter used for flight reference. Avoid mounting the digitizer in the direct airflow of hot or cold air inlets. The digitizer may be mounted in any position within the aircraft. Use 6-32 fasteners or 5/32" rivets to attach the mounting tray (P/N A30.03). Make sure the head of the fastener used does not protrude above the recess in the tray.

POWER INPUT

10 to 32 Volt DC power to the digitizer should be supplied directly from the main power buss of the aircraft. The circuit should be protected by a 2 – 3 amp circuit breaker or fuse meeting FAR 23.1357 requirements. (see figure 1) We do not recommend that transponder switched power be used for digitizer power. See section 3 for pin out information.

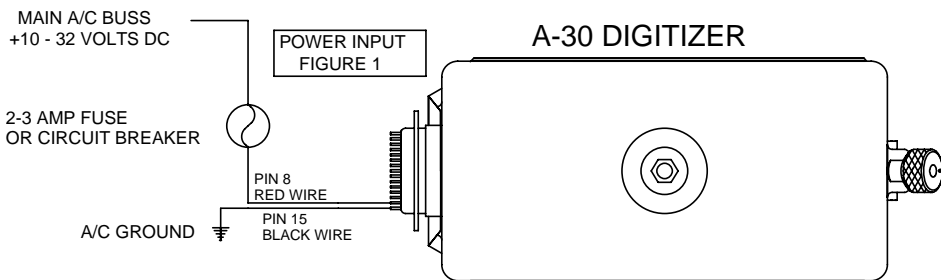

PITOT-STATIC CONNECTION

Pitot-Static hookup to the A-30 is through the port in the top of the case. The factory installed port is designed to use 3/16" diameter EPDM hose which is enclosed with the unit. An optional 1/8" NPT port fitting (P/N A30.06.02) is also included with the unit. Refer to FAR 23.1325.

- 1. Identify the static source line which is connected to the primary flight altimeter used for flight reference.**
- 2. If installing into an aircraft with no static system, determine the source of static pressure that is used by the primary flight altimeter. At that source place an "T" fitting which will allow you to connect the EPDM hose (P/N A30.06.04) which is supplied with the unit to that source.**
- 3. Chose a location in the static line that is accessible and is as close to the digitizer as possible. Provide for positive drainage of moisture and routing of the line as per FAR 23.1325 PAR (b) (1) & (11) (See figure 2)**
- 4. Cut the static line at this location. Make sure not to contaminate the inside of the static line when cutting it. Use a razor blade on plastic line and a tubing cutter on metal line.**
- 5. Install the plastic "T" fitting supplied (P/N A30.06.05) in the static line. If installing this fitting in plastic static line use the two reducing rubber adaptors supplied (P/N A30.06.06). If installing this fitting in metal static line cut two 1" long pieces from the EPDM. Secure the "T" fitting and rubber hose using the supplied spring clamps. (P/N A30.06.07 & A30.06.08) (See Figure 2)**
- 6. Secure the end of the EPDM hose to the port on the digitizer. Use the spring clamp supplied (P/N A30.06.07) to retain the hose to the port.**

7. If the alternate 1/8" NP static connection is to be used, remove the top cover and install the alternate port fitting (P/N A30.06.02). See section 4 cover removal procedure. You may also connect the alternate port to the existing port by cutting a short piece of the EPDM hose and connecting it between fittings and securing each end with the supplied spring clamps. (See figure 2)

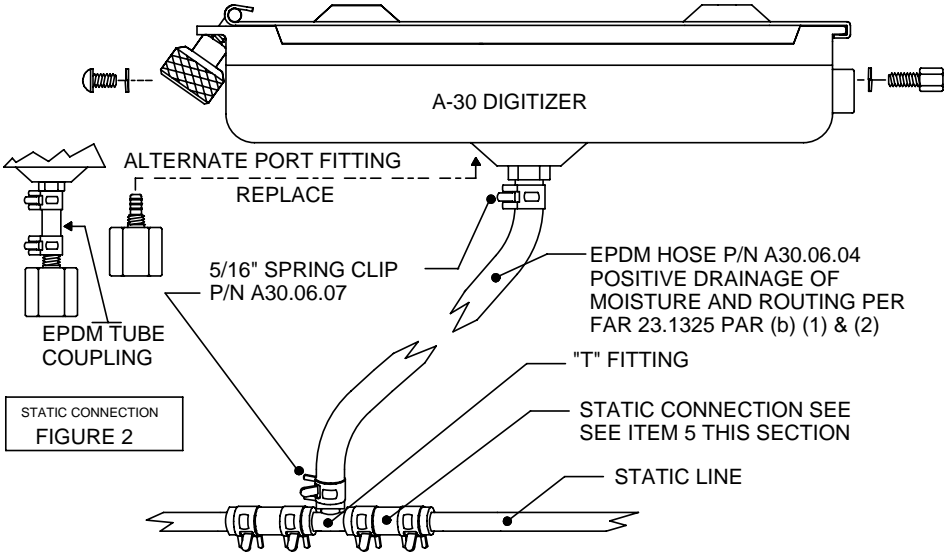

SECTION 3 PIN OUT

A connecting cable (P/N A30.11.01) is supplied with the digitizer. The cable is color coded to facilitate transponder connection. Please verify proper location of the color coded wires before installing the cable. On MOD 8 and up digitizers an add on wire kit is included (P/N A30.11.02) to provide output for the two RS 232 outputs and the D4 data line. These wires must be inserted in the 15 pin jack. See figure 3 for proper placement of these wires. The wire provided is tested by us and meets the requirements of FAR 23.1359 and 23.853.

DP-15 FEMALE CONNECTOR

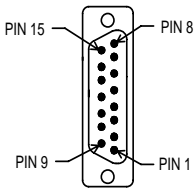

CABLE ASSEMBLY P/N A30.11.01

**PIN OUT
FIGURE 3**

PIN#	COLOR	PIN#	COLOR
8	RED	15	BLACK
7	NONE	14	NONE
6	BROWN	13	VIOLET
5	LT BROWN	12	GRAY
4	BLUE	11	PINK
3	WHITE	10	ORANGE
2	GREEN	9	YELLOW
1	NONE		

NOTE: ON MOD 8 AND ABOVE BOXES INSERT THESE WIRES INTO THE JACK AS REQUIRED.
 PIN COLOR
 1 BLUE/WHITE
 7 GREEN/WHITE
 14 GRAY/WHITE
 D4/RS232 ADD ON WIRE KIT P/N A30.11.02

PIN ASSIGNMENT AND COLOR CODE

PIN	FUNCTION	COLOR
1	D4	BLUE/WHITE*
2	A1	GREEN
3	A2	WHITE
4	A4	BLUE
5	B1	LIGHT BROWN
6	STROBE	BROWN
7	RS232 OUT	GREEN/WHITE*
8	+12-24 VDC	RED
9	B2	YELLOW
10	B4	ORANGE
11	C1	PINK
12	C4	GRAY
13	C2	VIOLET
14	RS232 OUT	GRAY/WHITE*
15	GROUND	BLACK

AVAILABLE ONLY ON MOD 8 AND ABOVE

SECTION 4 RS 232 OUTPUTS

To change the RS 232 data formats configure the jumpers as shown in figure 4 below. The default configuration is Trimble/Garmin 9600 baud with 10 foot resolution. Each output may be individually selected. To change the data ports remove the cover by removing the four (4) cover retaining screws (See figure 2). Lift the cover from the end furthest from the 15 pin connector until the static port fitting is pulled free from the internal rubber connector. Once the cover has been lifted enough, move the cover sideways off of the 15 pin jack. See figure 4 to select the data format which is required at each port and reinstall the cover. (See figure 4)

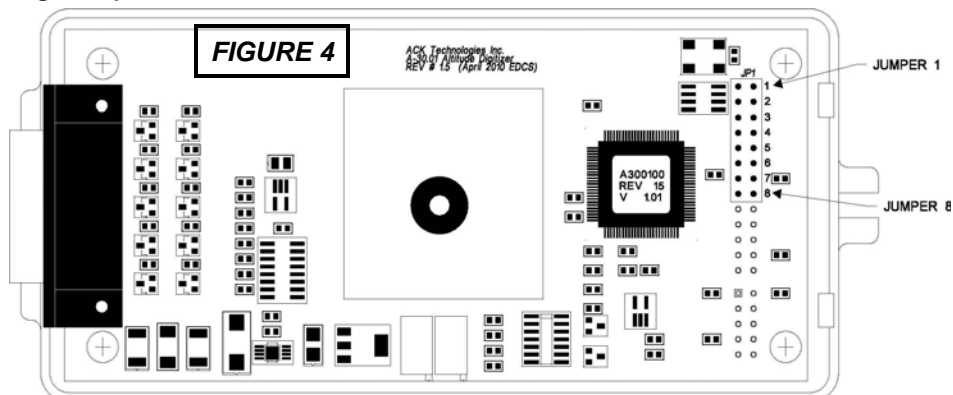

BLACK BOXES INDICATE AN INSTALLED JUMPER, AND THE PIN TRANSMITTING THE RS 232 DATA

JUMPER	TRIMBLE GARMIN	UPS/GARMIN II MORROW	NORTHSTAR	MAGELLAN	AIRNAV	UPS AT 618 II MORROW	MICROAIR UAV
	9600 bps 10-byte	1200 bps 17-byte	2400 bps 10-byte	1200 bps 17-byte	9600 bps 24-byte	1200 bps 17-byte	9600 bps 24-byte
1		PIN 14		PIN 14		PIN 14	
2			PIN 14	PIN 14			PIN 14
3					PIN 14	PIN 14	PIN 14
4		PIN 7		PIN 7		PIN 7	
5			PIN 7	PIN 7			PIN 7
6					PIN 7	PIN 7	PIN 7
7	INSTALL JUMPER FOR 10 FOOT RESOLUTION ON PIN 14						
8	INSTALL JUMPER FOR 10 FOOT RESOLUTION ON PIN 7						

SECTION 5 CALIBRATION

The Model A-30 Digitizer is calibrated typically to within +- 50 feet straight line fit from it's highest and lowest reporting altitude using NIST traceable pressure standards. For most installations little or no adjustment is necessary to match the Digitizer to the altimeter. Altimeters which are on the high or low side of the requirements of TSO C-10b may require correspondence adjustment. FAR 91.217 requires that altitude Digitizers must be calibrated when installed. FAR 91.413 requires calibration any time installation or maintenance is performed on a Transponder/Digitizer system.

CALIBRATION PROCEDURE

1. Calibration should be done with both the primary flight altimeter and Digitizer at the same ambient temperature within the range of +55 to +95 degrees Fahrenheit (+15 to +35 degrees centigrade). Power supplied to the Digitizer should be of the same nominal voltage as the aircraft buss voltage to which it is to be installed. The digitizers are factory calibrated at 14V nominal voltage, when calibrating using 24V buss voltage the factory calibration will be 100-200 feet off at sea level.

2. Apply power to the Digitizer for at least 5 minutes before proceeding with the calibration.

3. Determine the altitude to which you will be calibrating the encoder. Supplied with the Digitizer are four (4) altimeter placards. (See figure 5)

4. With the primary flight altimeter set to 29.92 in hg, decrease the system pressure supplied by the pitot –static test set until the primary flight altimeter indicates 50 feet lower than the maximum altitude to which you are calibrating.

5. Check the code transition point at this altitude and if required adjust the trim pot marked “H” until the transition point is within +50 feet of the primary flight altimeter with both increasing and decreasing pressure. (See figure 6)

6. Increase system pressure until the primary flight altimeter indicates +50 feet. If required adjust the trim pot marked “L” until the transition point is within 10 feet of this altitude with both increasing and decreasing pressure.

7. Repeat steps 4 through 6 until an accuracy of +- 50 feet is obtained for both increasing and decreasing pressure at both maximum calibration altitude and 0 foot altitude.

8. Install a placard which corresponds to the maximum altitude to which the Digitizer was calibrated on the front center face of the primary flight altimeter.

FAR 91.217 requires that a correspondence check be performed. AC43-6B provides guidance on acceptable methods to accomplish this.

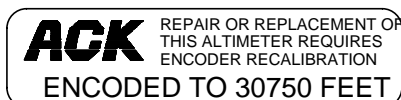
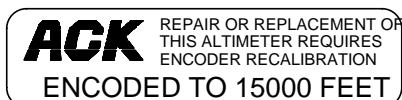

ALTIMETER PLACARDS P/N A30.09.02

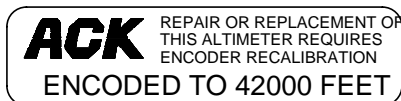
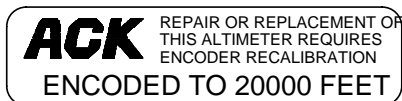

FIGURE 5

SECTION 6 OPERATION

The operation of the A-30 Digitizer is controlled by the aircraft transponder. Place the transponder in the altitude reporting mode to transmit altitude data. Model A-30 digitizers which transmit RS 232 data (mod 8 and above) provide continuous data to RS 232 devices.

The air traffic control system standard allows for use of mode C altitude information that is up to 249 feet in error. A properly functioning and calibrated Digitizer may report mode C altitude deviations of up to +/- 200 feet to ATC. This error is a result of a number of factors present in the aircraft and ATC system.

All Digitizers report altitude based on standard pressure of 29.92 in Hg. If your aircraft is equipped with a transponder or other device that displays pressure altitude without barometric correction we recommend that regular periodic checks of the displayed altitude be made. To do this, set the altimeter to 29.92 in Hg and verify that the altitude display indicates altitude that is within 200 feet of the altimeter.

If your aircraft is equipped with a GPS or other device which displays barometrically corrected altitude from the RS 232 data, set the altitude correction the same for both the device and the altimeter. The difference in altitude indications should be less than 249 feet.

If no altitude readout device is available in the aircraft we recommend that the accuracy of the device be periodically verified with ATC controllers. Make sure that the altimeter barometric pressure is set to the proper value for your location. The altitude reported by the controller and the altimeter indication should not deviate by more than 200 feet.

Air traffic controllers are required to verify the accuracy of the Digitizer before the altitude data can be used for separation of traffic. If notified by a controller "altitude squawk deviates by (number of feet) stop altitude squawk" this indicates that your altimeter, Digitizer or transponder is malfunctioning and should be inspected by a certified repair facility.

If an air traffic controller reports "no altitude squawk" the most likely problem is with the aircraft transponder.

The warm-up times listed in the specifications are for initial power up of the Digitizer. Ambient temperature is the temperature to which the Digitizer has subjected to prior to warm-up.

SECTION 7 CONTINUING AIRWORTHINESS

There are no periodic continuing maintenance requirements for the model A-30 Digitizer. Repair or service should be performed when the Digitizer no longer meets the accuracy requirements. FAR regulations require periodic calibration when used for IFR flight.

SECTION 8 SPECIFICATIONS

Approvals: FAA TSO C-88a
 German LBA 10.221/4

Range: MOD 5 –950 to 30,750 feet
 MOD 9 –950 to 42,000 feet

Accuracy: Typical +/- 20 feet
 Maximum +/- 50 feet

Size: L 6" W 2.65" H 1.3"
Weight 5.1 oz (144 grams)

Operating voltage: 10 to 32 VDC

Operating current: 160 mA typical

Operating temp: -4 to +131° F
 -20 to +55° C

Warm-up current draw:
 14VDC 160 mA
 28VDC 220 mA

Warm-up time:
 70° F ambient 60 seconds
 0° F ambient 210 seconds

Altitude resolution:
 Gray code (parallel) output 100ft
 RS 232 10ft or 100ft

DO-160B ENVIRONMENTAL CATEGORIES
C4BA/JKLMNOPS/XXXXXXZZBBBXXX

DO-178B NOT APPLICABLE CONTAINS NO MICROPROCESSOR

The cable assembly supplied with the digitizer is tested and complies with all requirements of FAR 23.1359 and FAR 23.853 and is suitable for installation in any part 23 aircraft.

SECTION 9 PARTS LIST PARTS SUPPLIED WITH THE A-30 DIGITIZER

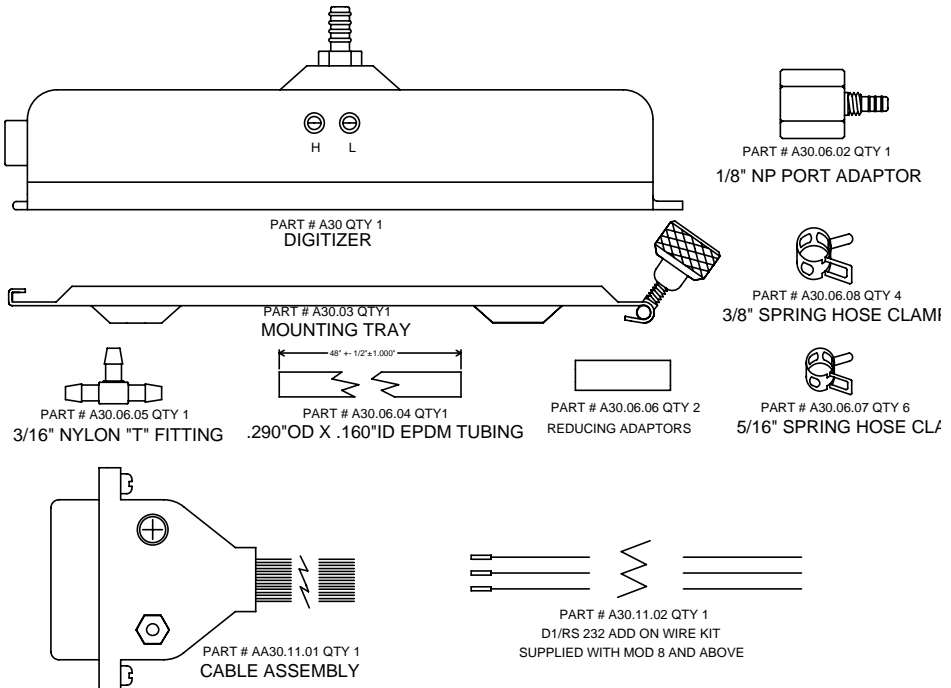

SECTION 10 TRANSPONDER CONNECTION

Data transfer to the transponder is accomplished by connecting the data lines C1 through A4 to their corresponding pins on the transponder. D4 is connected when reporting is required above 30,750 feet. Ground pin 6 of the model A-30 digitizer unless instructed otherwise by the transponder manufacturer. Some modern transponders will accept RS 232 serial data. Consult the transponder manufacturers installation instructions for proper connection and RS 232 configuration.

CABLE P/N A30.11.01											
PIN 2 GREEN	PIN 3 WHITE	PIN 4 BLUE	PIN 5 LT BROWN	PIN 9 YELLOW	PIN 10 ORANGE	PIN 11 PINK	PIN 13 VIOLET	PIN 12 GRAY	PIN 1 BLUE/W (1)	PIN 6 BROWN	
TRANSPONDER											
A1	A2	A4	B1	B2	B4	C1	C2	C4	D4		
14	13	15	19	17	16	21	18	20	10	11	ARC RT359A/459A/859A
16	15	14	17	19	18	22	21	20	23	(2)	BECKER ATC 2000/3401
1	2	3	14	15	16	17	18	19	20	(2)	BECKER ATC 4401
4	6	8	9	10	11	3	5	7	NC	(2)	BENDIX TRP-2060/2061/660
A	B	C	D	E	F	H	J	K	NC	(2)	BENDIX TR541A/641B
12	10	7	6	5	4	8	11	9	3	(2)	COLLINS TDR-950/950L
7	5	3	12	13	14	8	6	4	NC	2	EDO-AIRE RT-777
3	5	6	9	11	12	10	4	7	18	(2)	GARMIN 320/320A/327 (3)
4	5	6	7	8	9	10	11	12	NC	3	GENAVE BETA 5000
6	7	9	4	1	2	3	8	10	NC	(2)	KING KT76/78
M	K	J	E	C	B	D	L	H	8	(2)	KING KT76A/78A/76C/79
G	H	J	K	L	M	P	R	S	NC	B	KING 750A
6	7	8	9	10	11	12	13	14	NC	5	KING KT75
9	10	11	12	13	17	18	19	20	21	(2)	MICROAIR T2000
7	6	8	12	10	9	14	11	13	NC	5	NARCO AT50/50A/150 (4)
2	4	8	9	10	11	1	3	5	NC	12	NARCO AT5/6/6A
7	6	13	9	10	11	14	16	12	NC	19	RADAIR 250
5	17	16	15	2	14	3	4	18	NC	12	TERRA TRT250/250D
13	31	12	33	14	32	16	34	15	35	(2)	UPS/APPLLO SL70
K	C	W	T	L	D	P	F	Z	NC	(2)	WILCOX 1014A

(1) D4 PROVIDED ONLY ON MOD 8 AND ABOVE MODEL A-30 DIGITIZERS. NO CONNECTION ON MOD 7 AND BELOW MODEL A-30 DIGITIZERS.

(2) CONNECT TO AIRCRAFT GROUND

(3) TRANSPONDERS ACCEPT RS 232 ALTITUDE DATA IN SEE SECTION 4 OF THIS MANUAL FOR PROPER JUMPER SETTINGS WHEN USING SERIAL INPUT. CONSULT TRANSPONDER MANUFACTURERS INSTALLATION MANUAL FOR PROPER CONNECTION AND CONFIGURATION OF TRANSPONDER.

(4) SEE FIGURE 6 (PAGE 10) WHEN INSTALLING WITH NARCO AT50 OR AT50A TRANSPONDERS.

SECTION 11 TROUBLESHOOTING

NOTE: NARCO AT50 AND AT50A TRANSPONDERS CHASSIS NUMBER CNG218B4 OR CNR218B4 AND BELOW MUST BE MODIFIED AS PER NARCO SERVICE BULLETIN AT-50A-5 DATED 02/19/1975 FOR PROPER OPERATION.

NO MOD C ALTITUDE REPLY FROM TRANSPONDER IF MODE C FRAMING PULSES ARE PRESENT

- 1. Make sure Digitizer pin 6 is grounded unless directed otherwise by the transponder manufacturer.**
- 2. Make sure power is applied to pin 8 of the Digitizer and pin 15 is grounded.**
- 3. If using with a Narco AT50 or AT50A transponder see note above regarding service bulletin AT50-5.**
- 4. Make sure proper digitizer warm-up time has transpired.**

IF MODE C FRAMING PULSES ARE NOT PRESENT

- 1. Check transponder antenna for corrosion or poor airframe grounding. check VSWR of antenna and cable.**
- 2. Make sure the transponder is in altitude reporting mode. Mode A/C or Alt on transponder.**
- 3. Repair or replace transponder.**

TRANSPONDER ALTITUDE REPLY ERRATIC

- 1. Transponder not functioning properly. Repair or replace transponder.**
- 2. Intermittent data connection. Check parallel data connections.**
- 3. If Narco AT50 or AT50A transponder see Service bulletin A-30-5 which can be downloaded from our website www.ackavionics.com.**

ALTITUDE REPLY SHOWS DESCENT WHILE CLIMBING OR CLIMBING WHILE DESCENDING

- 1. One data input line not connected. Check parallel data input lines.**
- 2. Transponder not latching in one data line. Replace or repair transponder.**
- 3. If Narco AT50 or AT50A transponder see Service bulletin A-30-5 which can be downloaded from our website www.ackavionics.com.**

RS 232 TROUBLE SHOOTING

RS 232 IS ONLY AVAILABLE ON MOD 8 AND ABOVE DIGITIZERS

If there is no communication between the digitizer and the device you are interfacing the digitizer with.

- 1. Check to see that the digitizer jumpers are set correctly for the device you are trying to send data to. (see page 5 for jumper settings)*
- 2. Check to make sure the device you are sending data to is configured for the data you are sending from the digitizer.*

SECTION 12 WARRANTY

THE BACK COVER OF THIS MANUAL CONTAINS OUR COMPLETE LIMITED WARRANTY

To register your digitizer and activate the warranty please go to our website www.ackavionics.com and select product registration.

SERVICE

Model A-30 digitizers mod 4 and above (serial number 85,000 and above) must be returned to our facility for warranty repair or service. No field service is authorized on mod 4 and above digitizers.

Should it become necessary to return the digitizer for warranty repair or service to our facility, please call or email us before sending the unit.

Contact us at:

PHONE 408 287-8021

FAX 408 971-6879

Email: INFO@ACKAVIONICS.COM

All units must be returned to our facility freight prepaid. Our shipping address is as follows:

ACK TECHNOLOGIES, INC.

440 W. JULIAN ST.

SAN JOSE, CA 95110

Make sure that you have included a return address which is suitable for UPS return shipment. (no P.O. boxes or APO numbers)

Please include a short description of the problem you have been experiencing and a telephone number where you may be reached during the day.

LIMITED WARRANTY

THIS MODEL A-30 DIGITIZER IS WARRANTED BY ACK TECHNOLOGIES INC. AGAINST DEFECTS IN MATERIALS AND WORKMANSHIP FOR A PERIOD OF THREE YEARS FROM IT'S MANUFACTURING DATE. THIS WARRANTY IS VALID ONLY IF THE ENCLOSED WARRANTY CARD HAS BEEN COMPLETED AND RETURNED TO ACK TECHNOLOGIES INC. WITHIN 15 DAYS OF IT'S INSTALLATION. THIS WARRANTY IS LIMITED EXCLUSIVELY TO REPAIR OR REPLACEMENT OF THE MODEL A-30 DIGITIZER WHEN RETURNED FREIGHT PREPAID TO OUR MANUFACTURING FACILITY. THIS WARRANTY DOES NOT INCLUDE REPAIR OR REPLACEMENT OF ANY UNIT WHICH HAS BEEN IMPROPERLY USED , INSTALLED, OR WHICH IS PHYSICALLY DAMAGED. EXCEPT AS PROVIDED HEREIN ACK TECHNOLOGIES INC. MAKES NO EXPRESS WARRANTIES , AND ANY IMPLIED WARRANTY OF MERCHANTABILITY OR FITNESS FOR A PARTICULAR PURPOSE IS LIMITED IN IT'S DURATION TO THE DURATION OF THE WRITTEN LIMITED WARRANTIES SET FORTH HEREIN. ACK TECHNOLOGIES INC. SHALL NOT BE LIABLE FOR ANY DIRECT, INDIRECT, SPECIAL, OR CONSEQUENTIAL DAMAGES ARISING OUT OF THE USE OR MISUSE OF THIS PRODUCT. EXCEPT AS PROVIDED HEREIN NO EMPLOYEE, AGENT, DEALER, OR OTHER PERSON IS AUTHORIZED TO GIVE ANY WARRANTIES OF ANY NATURE ON BEHALF OF ACK TECHNOLOGIES INC.

YOU MAY HAVE ADDITIONAL LEGAL RIGHTS THAT VARY FROM STATE TO STATE

**ACK TECHNOLOGIES
INC.**

AVIONICS FOR GENERAL AND COMMERCIAL AVIATION

**440 WEST JULIAN STREET
SAN JOSE, CALIFORNIA 95110**

PHONE 408 287-8021

FAX 408 971-7879

[E-MAIL: INFO@ACKAVIONICS.COM](mailto:INFO@ACKAVIONICS.COM)