

XTreme - EFIS

Electronic Flight Information System

Operating Manual – English 1.07

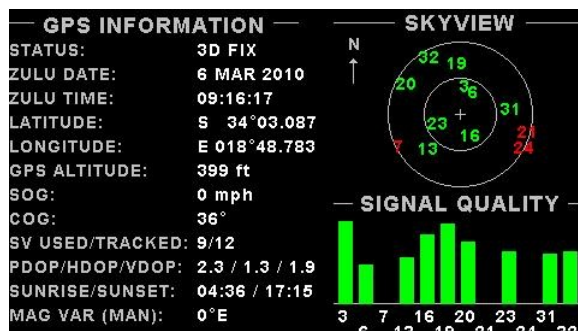

**** SAMPLE CHECKLIST ****
 NORMAL TEXT FILE WITH .ECL EXTENSION
 EACH LINE MUST BE TERMINATED IN CR
 MAXIMUM 60 CHARS PER LINE
 MAXIMUM 30 LINES PER CHECKLIST FILE

Introduction

The XTreme is a compact, multifunction electronic flight information system intended as a main flight instrument in smaller aircraft or as a backup/secondary flight instrument in larger aircraft. The XTreme, which fits a standard 3 1/8" instrument panel hole, contains all the necessary functionality to replace several flight and engine monitoring instruments.

All information is displayed in an easy to read format on a high resolution wide viewing angle 4.3" sunlight readable color display.

The XTreme's light weight, small size and high level of functionality makes it an excellent choice for all types of non-certified aircraft.

1 Features

Hardware:

- Powerful 32 bit ARM processor
- 4.3" high resolution 480x272, sunlight readable, wide viewing angle, 600 nits TFT LCD display
- LED backlight (brightness can be adjusted for low light flying conditions)
- Fits standard 3 1/8" aircraft instrument panel hole
- SD Card interface for data recording, user splash screens, checklists, graphic information pages, firmware upgrades, navigation and route files etc
- 1/8" NPT female fittings for Altitude and Airspeed pitot tube connections
- 1x RS232 communication port (Altitude encoder/VP-X/CO Monitor)
- 1x MGL Avionics Airtalk communication port
- 1x MGL Avionics RDAC communications port
- 1x CAN communication port
- Rotary control plus 5 independent buttons for easy menu navigation and user input
- External alarm switch output for an external indicator lamp etc
- Built in 50 Channel GPS receiver with over 1 million effective correlators with high immunity to jamming
- GPS Time To First Fix (TTFF) of less than 1 second
- External active GPS antenna connection
- Support for an internal or an external GPS receiver
- Built in RTC (Real Time Clock)
- Wide input supply voltage range of 8 to 30V DC
- Built in voltage reversal and over voltage protection for harsh electrical environments
- Light weight design



EFIS:

- Attitude display. Note (1)
- Magnetic heading indication. Note (2)
- Heading bug
- Precision altimeter from -1000ft up to a maximum of 30 000ft (-304m to 9144m). Altitude can be displayed in feet or meters.
- Altitude bug
- Airspeed indicator (16mph to 250mph), 1mph resolution. Airspeed can be displayed in mph, km/h or kts
- Digital and analog VSI indicator . Scale of 1000ft/min, 2000ft/min and 4000ft/min / 5m/s, 10m/s, and 20m/s. Resolution of 1ft/min, 1m/s
- Serial Altitude encoder output via the RS232 port
- Density altimeter
- OAT (Outside Air Temperature) display using an external OAT probe
- Supply Voltage display
- Stopwatch timer
- Automatic/Manual flight timer
- RTC (Real Time Clock)
- Glide and climb ratio indicator

- Barometer (actual local pressure)
- TAS (true airspeed) display
- G-Force indication. Note (1)
- Wind speed and wind direction indication. Note (2)
- Turn Indicator. Note (1)
- Slip/Skid indicator. Note (1)
- CDI indicator
- Waypoint and Route navigation
- GPS Flight Path (calculated artificial horizon based on GPS information)
- CO Monitor. Note (5)

Engine Monitor: Note (3)

- 1x Engine RPM
- 1x Rotor RPM
- 1x Manifold pressure
- 1x Oil pressure input
- 1x Oil temperature input
- 2x Auxiliary analog channels (Pressure/Temperature/Current)
- 12 Channel EGT/CHT display
- 2x Fuel Flow
- 2x Fuel Level
- Special Rotax 912/914 engine monitor mode utilizing the standard built in Rotax NTC CHT probes
- Programmable maintenance timer for scheduled routine engine maintenance
- Engine display screens are automatically configured to optimize screen space depending on what parameters are been displayed
- User settable Hobbs meter (password protected)
- Fuel range / endurance based on TAS or GPS ground speed
- Supply Voltage display
- Current monitor to measure charge/discharge currents. Note (4)
- Engine leaning feature
- Vertical Power VP-X display. Note (6)

General:

- Alarms on most displays
- Programmable maintenance timer for scheduled routine engine maintenance
- Programmable airframe timer for scheduled airframe maintenance.
- Records maximum and minimum values of most displayed values
- Built in black box recorder – records all flight data, engine, attitude and GPS data to SD card. Data can be exported to Google Earth, Microsoft Excel, etc.
- Includes a 1000 entry automatic flight log (Records start date&time, flight time, pilot number, Hobbs time, maintenance time, max altitude, airspeed and VSI reached during the flight)
- User configurable start up (Splash) screen
- Unlimited configurable checklists
- Unlimited configurable graphic information displays
- Automatic or manual local magnetic variation
- Dual menu system for quick item selection and user setups
- Sunrise/Sunset calculator
- Firmware upgrades via SD Card
- 1 year limited warranty

- (1) Requires optional MGL Avionics AHRS sensor unit (SP4/SP5/SP7)
- (2) Requires optional MGL Avionics compass sensor unit (SP2/SP6)
- (3) Requires optional MGL Avionics RDAC (Engine monitor) unit
- (4) Requires optional MGL Avionics current monitor sensor
- (5) Requires optional CO Guardian CO detector
- (6) Requires optional Vertical Power VP-X unit.



2 XTreme Layout

2.1 Front layout



2.2 Rear layout

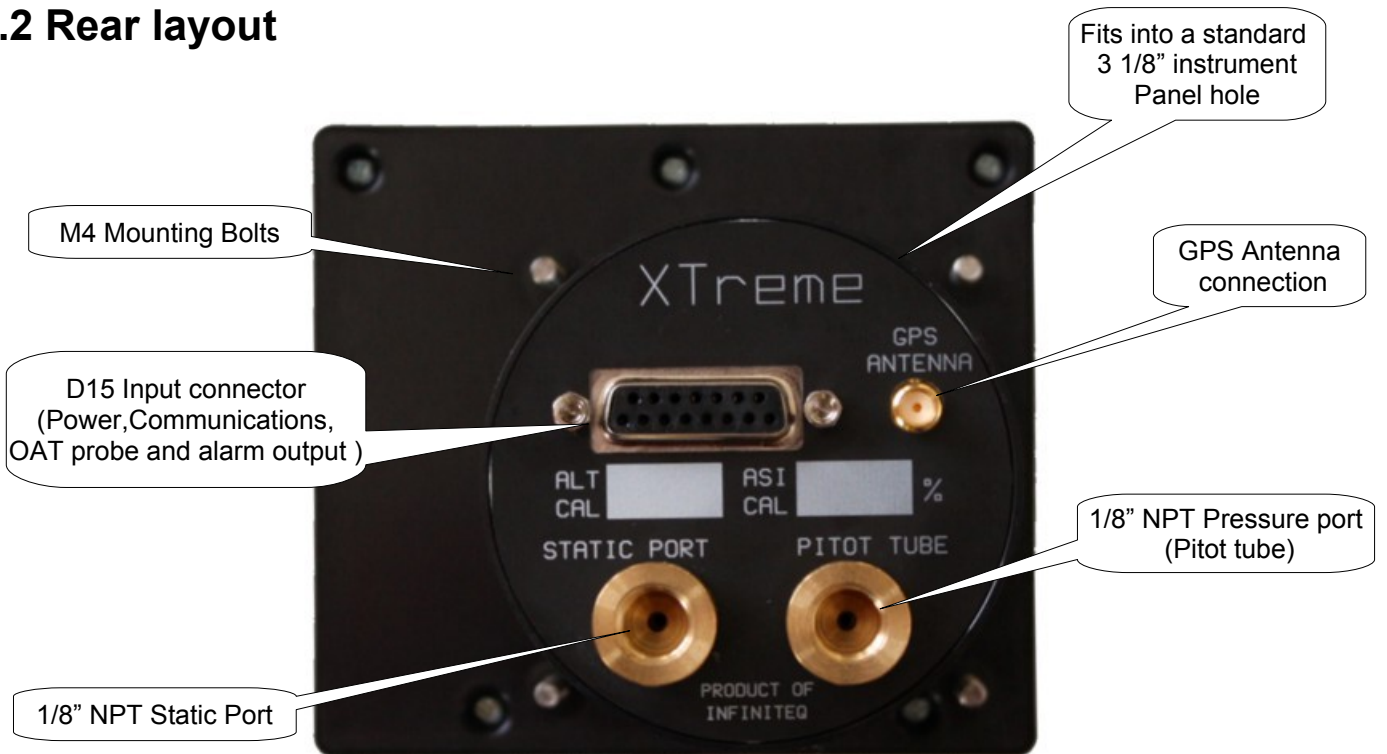

3 Display Screens

Press the left or right most soft keys to cycle through the display screens. The display screens can be enabled/disabled in the "DISPLAY SETUP" menu option.

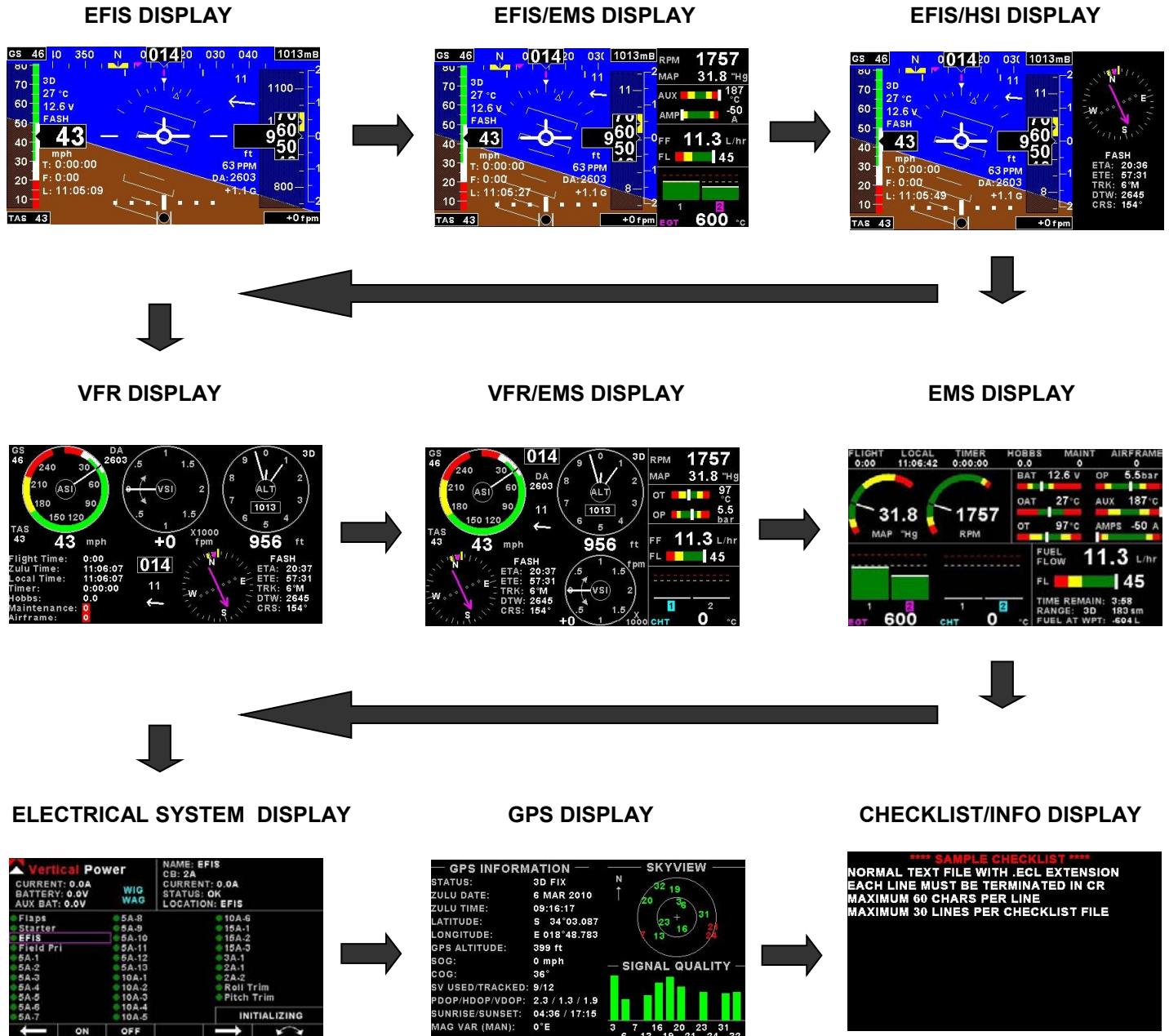

3.1 EFIS display

The EFIS information is displayed in a full screen format.



3.1.1 Heading tape



The heading tape is located at the top of the EFIS screen. The heading bug will be displayed in yellow if it is in the view area else it will turn cyan. The heading bug will always point to the shortest direction to achieve the correct heading. The heading bug can be changed in the quick select menu. The heading is corrected for attitude while pitching and rolling (MGL Avionics AHRS unit required (SP4/SP5/SP7)). The Compass parameters can be configured in the "COMPASS SETUP" menu. The small magenta triangle indicates coarse over ground from the GPS receiver. The coarse over ground indicator will only be displayed when a valid 2D or 3D GPS fix has been achieved. The heading tape source of information can be from a magnetic sensor (MGL Avionics SP2/6) or from the coarse over ground value from the GPS receiver. When the heading source of information is from the GPS receiver then the heading will be displayed in magenta.

3.1.2 Ground Speed **GS - - -**

This is located in the top left corner of the EFIS display. The ground speed value will only be displayed when a valid 2D or 3D GPS fix has been achieved.

3.1.3 Local Pressure Settings (QNH) **1013mB**

This is located in the top right corner of the EFIS display. Turn the rotary control to change the local pressure setting. The local pressure can be displayed in mB or in "HG.

3.1.4 True Airspeed (TAS) **TAS 0**

This is located in the bottom left corner of the EFIS display.

What is TAS and how is it calculated ?

TAS is indicated airspeed (IAS) compensated for altitude and temperature. Often pilots ignore the effect of temperature and only take altitude into account when converting IAS to TAS. For practical purposes this is quite accurate and gives a good reflection on your true airspeed. Keeping in mind that IAS measurement is subject to errors caused by airflow around your aircraft, there seems little point in taking this calculation to absolute resolution.

Again, we have decided to use a formula often used by pilots. This way the instrument reading will agree with what pilots are used to.

Add 1.75% of IAS per 1000 ft (304.9 m) increase in altitude above sea level.
We assume here that IAS = RAS (rectified air speed).

3.1.5 Airspeed Tape

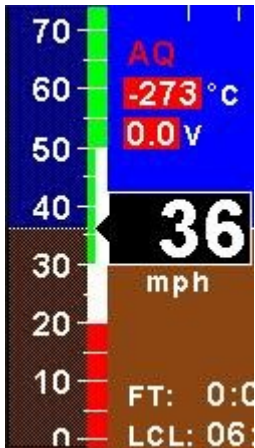

This is located to the left of the EFIS display. The Vso (Min safe speed, landing), Vs1 (Min safe speed, normal), Vfe (Max flap speed), Vno(Max maneuvering speed) and Vne (Max exceed speed) can be configured in the “AIRSPEED SETUP” menu.

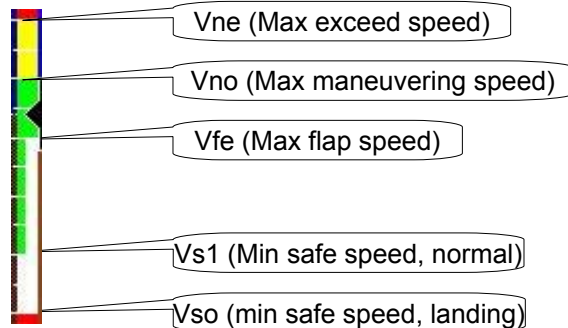

3.1.6 Information display area 1



The 1st line is the GPS fix status. AQ=Acquiring (Red text color), 2D=2D fix, 3D=3D fix.
 The 2nd line is the OAT value. Outside air temperature can be measured using the external temperature probe. The OAT parameters can be configured in the “OAT SETUP” menu.
 The 3rd line is the supply voltage value. The XTreme can measure the supply voltage up to 30Vdc. The supply voltage parameters can be configured in the “VOLTS SETUP” menu.
 The 4th line is the short name of the currently selected active waypoint.

3.1.7 Altitude Tape



This is located to the right of the EFIS display. The altitude bug will be displayed in yellow if it is in the view area else it will turn cyan in color . The altitude bug can be changed in the quick select menu. The altitude parameters can be configured in the “ALTITUDE SETUP” menu.

3.1.8 VSI displays

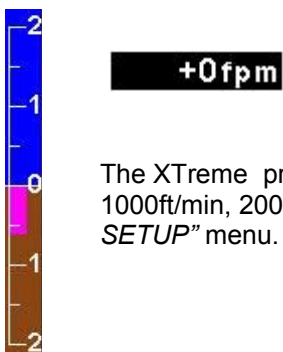

The XTreme provides an analog VSI as well as a digital readout. The VSI scale can be set for a scale of 1000ft/min, 2000ft/min or 4000ft/min / 5m/s, 10m/s, or 20m/s. The VSI parameters can be configured in the “VSI SETUP” menu.



3.1.9 Information display area 2

The 1st line is the carbon monoxide PPM value from the CO Guardian Detector (CO Guardian detector required).

The 2nd line is the density altitude value. Density altitude is a perceived altitude that pertains to your current altitude and temperature (and to a lesser extent on your current moisture content of the air). Density altitude is relevant for performance calculations of your aircraft. Density altitude affects the performance of your engine, propeller and airfoils. The most noticeable affects of density altitude are length of take-off and landing runs and the ability of your aircraft to carry weight. There are several methods to calculate density altitude, all result in readings that are very close to each other. We decided to implement a popular formula that is often used by pilots to calculate density altitude at their location.

T=Ambient temperature in degrees C
 Ts=15-.0019812*Pressure Altitude(ft)

Density Altitude=Pressure Altitude(ft)+118.6*(T-Ts)

The 3rd line is the current G-Force value. (MGL Avionics AHRS unit required (SP4/SP5/SP7)).

3.1.10 Timer area

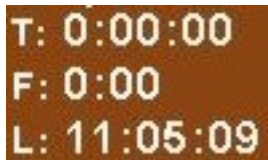

The 1st line is the timer. The Timer can be configured in the quick select menus.
 The 2nd line is the flight timer. The flight time is automatically reset to zero when a new flight is started (manual or automatic flight detection). The flight timer can be started in the quick select menu (Manual selection).
 The 3rd line is the local time. Local time normally includes a offset from Zulu time. The time offset can be setup in the "TIMERS SETUP" menu.

3.1.11 Slip/Skid indicator



This is located at the bottom of the display. The source of information for this indicator is derived from the accelerometer aligned with the pitch axis of the aircraft, i.e. the acceleration forces acting in the direction of the wings. The slip/skid ball can be enabled/disabled in the "HORIZON SETUP" menu

3.1.12 Turn indicator



This is located under the compass tape. The left and right notches indicate a (correctly balanced) rate 1 turn (3° per second). Therefore 180° turn will take 1 minute, 360° turn will take 2 minutes. The turn indicator can be enabled/disabled in the "HORIZON SETUP" menu

3.1.13 Horizon line, Roll and Pitch indicators

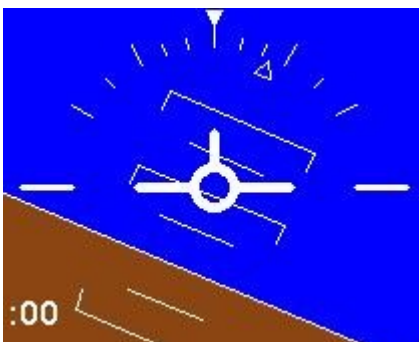

The horizon line separates the ground from the sky just like a conventional gyro based artificial horizon. The ground color can be selected to be shown in green or brown.

The roll markers have tick marks at 10, 20, 30, 45, 60 and 90 degrees of roll.

The pitch markers are horizontal with the horizon and are equally spaced with 5 degrees of separation between lines. The 10 degree pitch lines have a small pointer on each end which points towards the horizon.

The bank indicator can be configured for a moving type or a stationary type.

All the above parameters can be configured in the "HORIZON SETUP" menu.

3.1.14 Wind speed and direction



The XTreme has the ability to calculate and display the wind speed and direction.

The following variables must be available in order to calculate the wind speed and wind direction

-A valid 2D or 3D GPS fix (COG/SOG)

-Magnetic heading (MGL Avionics magnetic compass is required (SP2/SP6))

-TAS

The wind speed and direction will only be displayed if a valid 2D or 3D GPS fix has not been achieved. The wind speed and direction will display incorrect information when not in a straight and level flight.

3.1.15 CDI Indicator



The CDI indicator will be displayed at the bottom of the EFIS display when the pilot has selected an active waypoint to fly to. The CDI bar moves off the center to indicate which direction you must fly in order to stay on the original course. If the CDI is to the left then fly left until the CDI Bar is in the center of the “tick” markers. The “tick” marker scale can be setup in the “*GPS SETUP*” menu.

3.2 EFIS Quick Select Menu System



Press the rotary control when the EFIS screen is displayed to access the EFIS quick select menu.

MARK WAYPOINT:



Select this menu option to mark a waypoint. The latitude, longitude and altitude are automatically set based on the current location. Enter a short name and long name for the waypoint so you can easily identify it. Press save once you have finished editing and to save the waypoint to the waypoint.ewd file.

START FLIGHT:

Select this option to manually start/stop a flight. This menu option is only shown if the XTreme is setup to select the manual flight option under the "FLIGHT LOG" setup menu. The flight timer "F", "FLIGHT" or "FLIGHT TIME" text will flash to indicate that a valid flight is in progress.

REALIGN AHRS:



If the following message appears then you have to realign the AHRS. This is due to excessive maneuvering or exceeding the maximum bank, pitch or yaw rates. Select this function to indicated to the instrument that you are flying straight and level and that gravity tracking may be accelerated to ensure rapid realignment of the horizon.

LEVEL PITCH:

You can level the pitch of the artificial horizon should your aircraft fly "nose up" or "nose down" due to trim.

ALTITUDE BUG:



Use the rotary control to adjust the altitude bug. Press the "ON/OFF" soft key to enable or disable the altitude bug icon.

HEADING BUG:

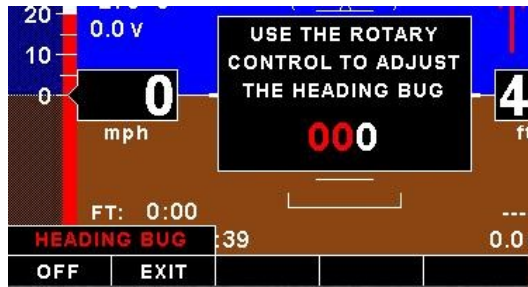

Use the rotary control to adjust the heading bug. Press the "ON/OFF" soft key to enable or disable the heading bug.

TIMER:



Select this menu option to configure the timer. Use the rotary control to adjust the timers reset value. Press the "UP/DOWN" soft key to select whether the timer must count up or down, the "START/STOP" soft key to start or stop the timer and the "ON/OFF" soft key to enable or disable the timer.

MIN/MAX:



Select this menu option to display the maximum and minimum captured values. Press the "RESET" soft key to reset the min/max values to the current values.

BACKLIGHT:



Select this menu option to adjust the backlight brightness level. This may be desirable during low light flying conditions. Use the rotary control to adjust the brightness level.

MENU:

Select this menu option to enter the main menu system.

3.3 AHRS Failure

The EFIS display will have the following indicators crossed out in case of a AHRS failure (SP4/SP5/SP7).



3.4 EFIS/EMS Display

The EFIS/EMS displays the EFIS in a 2/3 screen format and the engine data in a 1/3 screen format.



3.4.1 EFIS Display

The 2/3 EFIS display is in the same layout format as the full EFIS display. Please see the section 3.1 for more information.

3.4.2 RPM/Rotor/MAP display section

The RPM/Rotor/MAP section will maximize the space according to which parameter is enabled. The RPM, Rotor and MAP parameters can be configured in the "EMS SETUP" menu.



RPM, Rotor and MAP enabled.



RPM and MAP enabled.



RPM only.



MAP only.



If the RPM, Rotor and MAP displays are disabled then the Hobbs, maintenance and airframe timers will be shown.

3.4.3 Oil Temperature, Oil Pressure, Current and Auxiliary analog display section



This section displays the oil temperature, oil pressure, as well as the 2 auxiliary analog channels (display labels are configurable). If more then 2 channels are enabled then the display area will alternate at a 3 second interval. The oil temperature/pressure as well as the 2 auxiliary analog channels can be configured in the “EMS SETUP” menu.

3.4.4 Fuel display section

The XTreme supports dual fuel flow and dual fuel levels. The fuel section will automatically try and maximize the display area according to the fuel parameters selected. The XTreme has 20 different fuel modes of operation. The fuel parameters can be configured in the “FUEL SETUP” menu.

3.4.4.1 Single fuel flow and calculated tank level (single tank)

- Single fuel flow and fuel level sender (single tank)
- Differential fuel flow and calculated tank level (single tank)
- Differential fuel flow and fuel level sender (single tank)
- Summed fuel flow and calculated tank level (single tank)
- Summed fuel flow and fuel level sender (single tank)



3.4.4.2 Dual fuel flow and calculated tank levels (dual tank)

- Dual fuel flow and dual fuel level senders (dual tank)

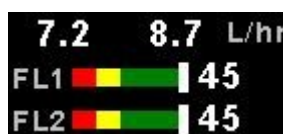

3.4.4.3 Single fuel flow and dual fuel level senders (dual tank)

- Single fuel flow, single fuel level sender, single calculated tank
- Differential fuel flow and dual fuel level senders (dual tank)
- Differential flow, single fuel level sender, single calculated tank
- Summed fuel flow and dual fuel level senders (dual tank)
- Summed fuel flow, single fuel level sender, single calculated tank



Single/Differential/Summed fuel flow, single fuel level sender, single calculated tank

These modes are nice for multiple fuel tanks whereby one or more tanks are difficult to insert level senders in. Potential problems such as those listed below can easily be diagnosed by doing side by side comparisons between a calculated and physical tank.

- Leaks in the fuel system
- Uneven drain of interconnected tanks
- Malfunction of the level sender
- Malfunction of the flow sender

3.4.4.5 Single fuel flow only indicator

This mode is displayed if either fuel flow 1 or fuel flow 2 is selected and no fuel level senders are selected.



3.4.4.6 Dual fuel flow indicator

This mode is displayed if both fuel flow 1 and fuel flow 2 are selected and the fuel mode is selected for dual flow. Both fuel level senders are disabled.

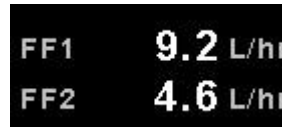

3.4.4.7 Single tank level indicator

This mode is displayed if either fuel level 1 or fuel level 2 is selected. Both fuel flow senders are disabled.



3.4.4.8 Dual tank level indicator

This mode is displayed if both fuel level 1 and fuel level 2 are selected. Both fuel flow senders are disabled.



3.4.4.9 Differential/Summed fuel flow

This mode is displayed if both fuel flow 1 and fuel flow 2 are selected and the fuel mode is selected for either differential or summed.



3.4.5 EGT/CHT display section



The XTreme supports up to 12 thermocouples for EGTs/CHTs. The EGT/CHT section will automatically try and maximize the display area according to the number of EGTs/CHTs selected. The EGT/CHT parameters can be configured in the "EGT SETUP" and "CHT SETUP" menu.

The EGT/CHT number will highlight to the indicated temperature value if "HIGHEST" is selected. The EGT highlight color is magenta, and the CHT color is cyan.

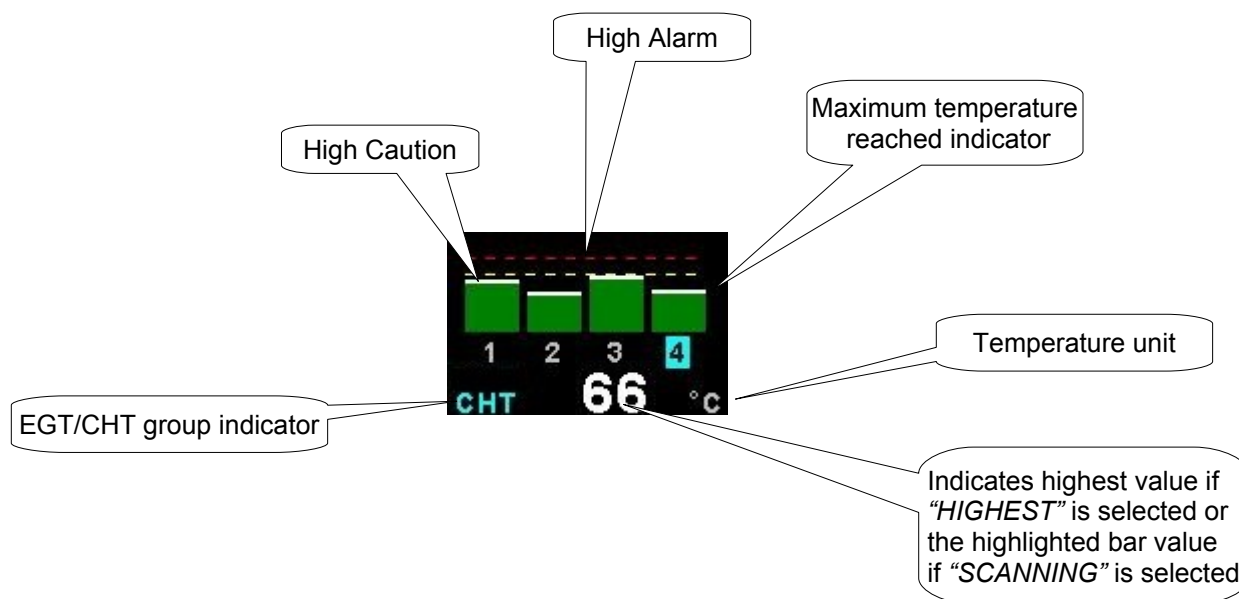

3.5 EFIS/EMS Quick Select Menu System



Press the rotary control when the EFIS/EMS screen is displayed to access the quick select menu.

MARK WAYPOINT:

See section 3.2 for more information.

START FLIGHT:

See section 3.2 for more information.

REALIGN AHRS:

See section 3.2 for more information.

LEVEL PITCH:

See section 3.2 for more information.

ALTITUDE BUG:

See section 3.2 for more information.

HEADING BUG:

See section 3.2 for more information.

FUEL REFILL:

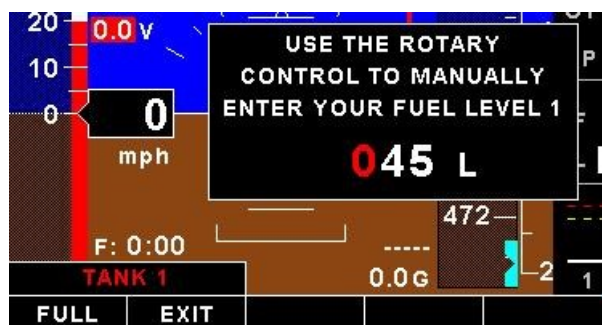

Select this menu option to refill a calculated fuel tank. Press the "FULL" soft key for a quick fill to the full reading in the tank setup menu. Press the "EXIT" soft key when done.

FUEL TOTALS:

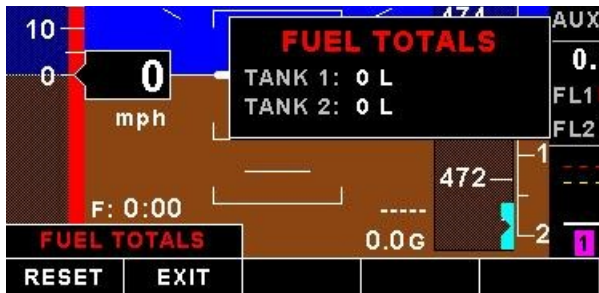

Select this menu option to display the fuel totals. Press the “RESET” soft key to reset the totalisers to zero. Press the “EXIT” soft key when done.

TIMER:

See section 3.2 for more information.

MIN/MAX:

See section 3.2 for more information.

BACKLIGHT:

See section 3.2 for more information.

MENU:

Select this menu option to enter the main menu system.

3.6 EFIS/HSI Display

The EFIS/HSI displays the EFIS in a 2/3 screen format and the navigation information in a 1/3 screen format.



3.6.1 EFIS Display

The 2/3 EFIS display is in the same layout format as the full EFIS display. Please see the section 3.1 for more information.

3.6.2 Navigation Display

The XTreme displays the navigation information in a form of a HSI (Horizontal Situation Indicator)

Heading:

The yellow bar at the top points to your heading. It is also known as the lubber line.

Compass Rose:

The compass rose is the 360 degree circle around the HSI. It is broken down into 5 degree divisions.

Heading Bug:

The 2 yellow lines indicate the heading bug. The heading bug can be adjusted in the quick select menu system.

Coarse Selector:

The magenta arrow (Indicating that the information is coming the internal GPS) points in the direction which you must fly in order to reach the active waypoint.

CDI (Coarse Deviation Indicator):

The center line of the Coarse Selector moves off the center to indicate which direction you must fly in order to stay on the the original coarse. If the CDI is to the left then fly left until the CDI lines up with the Coarse selector. The "tick" marker scale can be setup in the "GPS SETUP" menu.

Navigation Information:

Under the HIS you will find the short name of the active waypoint. You will also find the following information:

ETA: Estimated Time of Arrival.



ETE: Estimated Time En Route.

TRK: GPS ground track.

DTW: Distance to waypoint.

CRS: The current set course to the active waypoint.

3.7 EFIS/HSI Quick Select Menu System

EXIT
MARK WAYPT
START FLIGHT
REALIGN AHRS
LEVEL PITCH
ALTITUDE BUG
HEADING BUG
TIMER
MIN/MAX
BACKLIGHT
MENU

Press the rotary control when the EFIS/HSI screen is displayed to access the quick select menu.

MARK WAYPOINT:

See section 3.2 for more information.

START FLIGHT:

See section 3.2 for more information.

REALIGN AHRS:

See section 3.2 for more information.

LEVEL PITCH:

See section 3.2 for more information.

ALTITUDE BUG:

See section 3.2 for more information.

HEADING BUG:

See section 3.2 for more information.

TIMER:

See section 3.2 for more information.

MIN/MAX:

See section 3.2 for more information.

BACKLIGHT:

See section 3.2 for more information.

MENU:

Select this menu option to enter the main menu system.

3.8 VFR Display

The VFR display shows the altitude, airspeed, VSI and navigation in a full screen format.



3.8.1 Airspeed Dial



This displays the airspeed as a traditional analog airspeed indicator. A digital readout of the airspeed value is also displayed below the dial. The V_{so} (min safe speed, landing), V_{s1} (min safe speed, normal), V_{fe} (max flap speed), V_{no}(max maneuvering speed) and V_{ne} (max exceed speed) can be configured in the “AIRSPEED SETUP” menu.

3.8.2 Altitude Dial



This displays the altitude as a traditional 3 needle analog altimeter. A digital readout of the altitude value is also displayed below the dial. The altitude parameters can be configured in the “ALTITUDE SETUP” menu.

The local pressure setting (QNH) is located in the bottom center of the altitude dial. Turn the rotary control to change the local pressure setting. The local pressure can be displayed in mB or in “HG.

3.8.3 VSI indicator

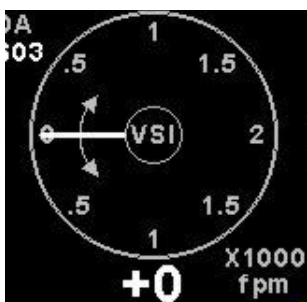

This displays the VSI as a traditional VSI indicator. The scale and units can be configured in the “VSI SETUP” menu.

3.8.4 Ground Speed



This is located in the top left corner of the VFR display. The ground speed value will only be displayed when a valid 2D or 3D GPS fix has been achieved.

3.8.5 True Airspeed (TAS)



Please see section 3.1.4 for more information.

3.8.6 GPS Fix Status



GPS fix status. AQ=acquiring (Red text color), 2D=2D fix, 3D=3D fix.

3.8.7 Density Altitude



Please see section 3.1.9 for more information.

3.8.8 Wind speed and Direction



Please see section 3.1.14 for more information.

3.8.9 Heading Box



The heading is corrected for attitude while pitching and rolling (MGL Avionics AHRS unit required (SP4/SP5/SP7)).The Compass parameters can be configured in the “COMPASS SETUP” menu. The heading source of information can be from a magnetic sensor (MGL Avionics SP2/6) or from the coarse over ground value from the GPS receiver. When the heading source of information is from the GPS receiver then the heading will be displayed in magenta.

3.8.10 Information display area 1

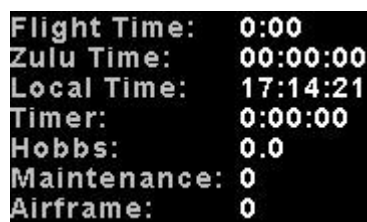

Flight Time:

The flight time is automatically reset to zero when a new flight is started (manual or automatic flight detection). The text “FLIGHT TIME” will flash when a flight is active. The flight timer can be started in the quick select menu (Manual flight mode).

Zulu Time:

This is also know as UTC or GMT time. The RTC (real time clock) can be selected to either use the internal RTC or from the GPS (external or internal). The RTC can be setup in the “TIMERS SETUP” menu.

Local Time:

Local time normally includes an offset from Zulu time. The time offset can be setup in the “TIMERS SETUP” menu.

Timer:

The Timer can be configured in the quick select menu.

Hobbs:

The XTreme contains a password protected Hobbs timer. The Hobbs time can be set to the current known engine time in the "TIMERS SETUP" menu. The Hobbs timer will only increment when the RPM is greater then the "HOBBS MINIMUM RPM".

Maintenance:

This timer is set in engine hours and it will count down to zero when the engine RPM is greater then the "HOBBS MINIMUM RPM" value as set in the "TIMERS SETUP". A good use for this function is to set the hours until your next spark plug change or engine inspection.

The purpose of this function is to assist you in determining remaining hours until maintenance will be required. It is not intended as a replacement for the aircraft's maintenance log. It is therefore important that the aircraft's maintenance log be maintained in the normal manner. You should further use your own discretion in performing maintenance earlier than indicated should any aircraft performance problems arise.

MAINTENANCE TIMER HAS EXPIRED

A maximum of 999 hours can be entered as a maintenance interval. A reminder message will appear on startup when zero hours are remaining. The reminder message will automatically disappear after 10 seconds or if the pilot presses any key. Engine running time for the

purpose of the maintenance timer is defined as the run time where the engine RPM is greater than the "HOBBS MINIMUM RPM" value as set in the "TIMERS SETUP".

Airframe:

This timer operates similar to the engine maintenance timer but is based on flight time. You might use it to schedule thorough airframe checks at intervals..

AIRFRAME TIMER HAS EXPIRED

A reminder message will appear on startup when zero hours are remaining. The reminder message will automatically disappear after 10 seconds or if the pilot presses any key.

3.8.11 Information area 2

Volts:	13.5 V
OAT:	19 °C
Glide Ratio:	0.0
Barometer:	952 mb
Fuel Endur:	0:00
Fuel Range:	0 sm

Volts:

The XTreme can measure the supply voltage up to 30Vdc. The supply volts parameters can be configured in the "VOLTS SETUP" menu.

OAT:

Outside air temperature can be measured using the external temperature probe. The OAT parameters can be configured in the "OAT SETUP" menu.

Glide Ratio:

Glide ratio can be measured up to 1:99. Glide ratio is measured as a ratio between forward movement of the aircraft vs. vertical sink rate. Please note that the forward movement of the aircraft is not synonymous with horizontal forward movement relative to the earth surface but is a function of airspeed.

Climb Ratio:

Climb ratio can be measured up to 1:99. Climb ratio is measured as a ratio between forward movement of the aircraft vs. vertical climb rate. Please note that the forward movement of the aircraft is not synonymous with horizontal forward movement relative to the earth surface but is a function of airspeed.

Barometer:

Ambient pressure can be displayed in either millibar (mb) or in Inches of Mercury ("Hg). The setup for the "PRESSURE UNIT" in the "ALTITUDE SETUP" menu will determine which.

3.8.12 Navigation Display

Please see section 3.6.2 for more information.

3.9 VFR Quick Select Menu System



EXIT
MARK WAYPT
START FLIGHT
HEADING BUG
TIMER
MIN/MAX
BACKLIGHT
MENU

Press the rotary control when the VFR display screen is displayed to access the quick select menu.

MARK WAYPOINT:

See section 3.2 for more information.

START FLIGHT:

See section 3.2 for more information.

HEADING BUG:

See section 3.2 for more information.

TIMER:

See section 3.2 for more information.

MIN/MAX:

See section 3.2 for more information.

BACKLIGHT:

See section 3.2 for more information.

MENU:

Select this menu option to enter the main menu system.

3.10 VFR/EMS Display

The VFR display shows the altitude, airspeed and VSI in the traditional round gauges with 1/3 of the screen reserved for engine data.



3.10.1 Airspeed Dial



This displays the airspeed as a traditional analog airspeed indicator. A digital readout of the airspeed value is also displayed below the dial. The V_{so} (min safe speed, landing), V_{s1} (min safe speed, normal), V_{fe} (max flap speed), V_{no} (max maneuvering speed) and V_{ne} (max exceed speed) can be configured in the "AIRSPEED SETUP" menu.

3.10.2 Altitude Dial



This displays the altitude as a traditional 3 needle analog altimeter. A digital readout of the altitude value is also displayed below the dial. The altitude parameters can be configured in the "ALTITUDE SETUP" menu.

The local pressure setting (QNH) is located in the bottom center of the altitude dial. Turn the rotary control to change the local pressure setting. The local pressure can be displayed in mB or in "HG.

3.10.3 VSI indicator



This displays the VSI as a traditional VSI indicator. The scale and units can be configured in the "VSI SETUP" menu.

3.10.4 Ground Speed



This is located in the top left corner of the VFR display. The ground speed value will only be displayed when a valid 2D or 3D GPS fix has been achieved.

3.10.5 True Airspeed (TAS)



Please see section 3.1.4 for more information.

3.10.6 GPS Fix Status



GPS fix status. AQ=acquiring (Red text color), 2D=2D fix, 3D=3D fix.

3.10.7 Density Altitude



Please see section 3.1.9 for more information.

3.10.8 Wind speed and Direction



Please see section 3.1.14 for more information.

3.10.9 Heading Box



The heading is corrected for attitude while pitching and rolling (MGL Avionics AHRS unit required (SP4/SP5/SP7)). The Compass parameters can be configured in the "COMPASS SETUP" menu. The heading source of information can be from a magnetic sensor (MGL Avionics SP2/6) or from the coarse over ground value from the GPS receiver. When the heading source of information is from the GPS receiver then the heading will be displayed in magenta.

3.10.10 Information display area 1

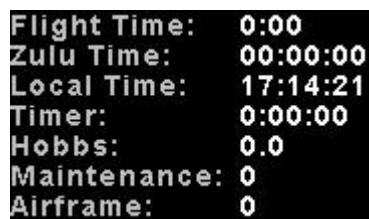

Flight Time:

The flight time is automatically reset to zero when a new flight is started (manual or automatic flight detection). The text "FLIGHT TIME" will flash when a flight is active. The flight timer can be started in the quick select menu (Manual flight mode).

Zulu Time:

This is also know as UTC or GMT time. The RTC (real time clock) can be selected to come from the internal RTC or from the GPS (external or internal). The RTC can be setup in the "TIMERS SETUP" menu.

Local Time:

Local time normally includes an offset from Zulu time. The time offset can be setup in the "TIMERS SETUP" menu.

Timer:

The Timer can be configured in the quick select menu.

Hobbs:

The XTreme contains a password protected Hobbs timer. The Hobbs time can be set to the current known engine time in the "TIMERS SETUP" menu. The Hobbs timer will only increment when the RPM is greater than the "HOBBS MINIMUM RPM".

Maintenance:

This timer is set in engine hours and it will count down to zero when the engine RPM is greater than the "HOBBS MINIMUM RPM" value as set in the "TIMERS SETUP". A good use for this function is to set the hours until your next spark plug change or engine inspection.

The purpose of this function is to assist you in determining remaining hours until maintenance will be required. It is not intended as a replacement for the aircraft's maintenance log. It is therefore important that the aircraft's maintenance log be maintained in the normal manner. You should further use your own discretion in performing maintenance earlier than indicated should any aircraft performance problems arise.

**MAINTENANCE TIMER
HAS EXPIRED**

A maximum of 999 hours can be entered as a maintenance interval. A reminder message will appear on startup when zero hours are remaining. The reminder message will automatically disappear after 10 seconds or if the pilot presses any key. Engine running time for the

purpose of the maintenance timer is defined as the run time where the engine RPM is greater than the "HOBBS MINIMUM RPM" value as set in the "TIMERS SETUP".

Airframe:

This timer operates similar to the engine maintenance timer but is based on flight time. You might use it to schedule thorough airframe checks at intervals, perhaps every 25 or 50 hours.

**AIRFRAME TIMER
HAS EXPIRED**

A reminder message will appear on startup when zero hours are remaining. The reminder message will automatically disappear after 10 seconds or if the pilot presses any key.

3.10.11 Information area 2

Volts:	13.5 V
OAT:	19 °C
Glide Ratio:	0.0
Barometer:	952 mb
Fuel Endur:	0:00
Fuel Range:	0 sm

Volts:

The XTreme can measure the supply voltage up to 30Vdc. The supply volts parameters can be configured in the "VOLTS SETUP" menu.

OAT:

Outside air temperature can be measured using the external temperature probe. The OAT parameters can be configured in the "OAT SETUP" menu.

Glide Ratio:

Glide ratio can be measured up to 1:99. Glide ratio is measured as a ratio between forward movement of the aircraft vs. vertical sink rate. Please note that the forward movement of the aircraft is not synonymous with horizontal forward movement relative to the earth surface but is a function of airspeed.

Climb Ratio:

Climb ratio can be measured up to 1:99. Climb ratio is measured as a ratio between forward movement of the aircraft vs. vertical climb rate. Please note that the forward movement of the aircraft is not synonymous with horizontal forward movement relative to the earth surface but is a function of airspeed.

Barometer:

Ambient pressure can be displayed in either millibar (mb) or in Inches of Mercury ("Hg). The setup for the "PRESSURE UNIT" in the "ALTITUDE SETUP" menu will determine which.

3.10.12 Navigation Page

Please see section 3.6.2 for more information.

3.11 VFR Quick Select Menu System

EXIT

**MARK WAYPT
START FLIGHT
HEADING BUG
FUEL REFILL
FUEL TOTALS
TIMER
MIN/MAX
BACKLIGHT
MENU**

Press the rotary control when the VFR screen is displayed to access the VFR quick select menu.

MARK WAYPOINT:

See section 3.2 for more information.

START FLIGHT:

See section 3.2 for more information.

FUEL REFILL:

See section 3.5 for more information.

FUEL TOTALS:

See section 3.5 for more information.

TIMER:

See section 3.2 for more information.

MIN/MAX:

See section 3.2 for more information.

BACKLIGHT:

See section 3.2 for more information.

MENU:

Select this menu option to enter the main menu system.

3.12 EMS Display

The engine data is displayed in a full screen format.

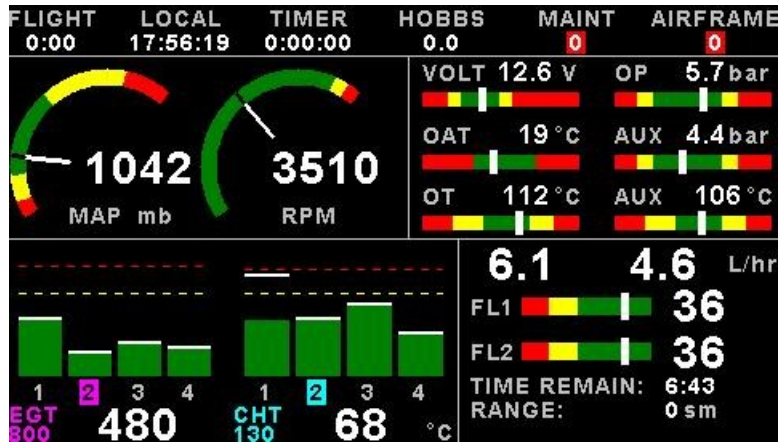

3.12.1 Information bar



FLIGHT:

The flight time is automatically reset to zero when a new flight is started (manual or automatic flight detection). The text “FLIGHT” will flash when a flight is active. The flight timer can be started in the quick select menu (Manual flight mode).

LOCAL:

Local time normally includes an offset from Zulu time. The time offset can be setup in the “TIMERS SETUP” menu.

TIMER:

See section 3.2 for more information.

HOBBS:

See section 3.6.9 for more information.

MAINT:

See section 3.6.9 for more information.

Airframe:

See section 3.6.9 for more information.

3.12.2 RPM/Rotor/MAP display section

The RPM/Rotor/MAP section will maximize the space according to which parameter RPM/Rotor/MAP is enabled. The RPM,Rotor and MAP parameters can be configured in the “EMS SETUP” menu.



RPM,Rotor and MAP enabled.

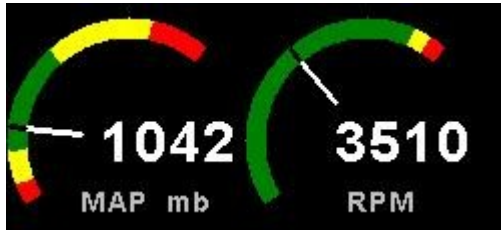

RPM and MAP enabled.



RPM only enabled



MAP only enabled

3.12.3 Volts, OAT, Oil Temperature/Pressure, Current and Auxiliary Analog section



This section displays the supply voltage, OAT, oil temperature, oil pressure, as well as the 2 auxiliary analog channels. The oil temperature/pressure as well as the 2 auxiliary analog channels can be configured in the "EMS SETUP" menu.

3.12.4 Fuel display section

The XTreme supports dual fuel flow and dual fuel levels. The fuel section will automatically try and maximize the display area according to the fuel parameters selected. The XTreme has 20 different fuel modes of operation. The fuel parameters can be configured in the "FUEL SETUP" menu. See section 0.0 for more information.

3.12.4.1 Single fuel flow and calculated tank level (single tank)

- Single fuel flow and fuel level sender (single tank)
- Differential fuel flow and calculated tank level (single tank)
- Differential fuel flow and fuel level sender (single tank)
- Summed fuel flow and calculated tank level (single tank)
- Summed fuel flow and fuel level sender (single tank)



**3.12.4.2 Dual fuel flow and calculated tank levels (dual tank)
Dual fuel flow and dual fuel level senders (dual tank)**



**3.12.4.3 Single fuel flow and dual fuel level senders (dual tank)
Single fuel flow, single fuel level sender, single calculated tank
Differential fuel flow and dual fuel level senders (dual tank)
Differential flow, single fuel level sender, single calculated tank
Summed fuel flow and dual fuel level senders (dual tank)
Summed fuel flow, single fuel level sender, single calculated tank**



Single/Differential/Summed fuel flow, single fuel level sender, single calculated tank

These modes are nice for multiple fuel tanks whereby one or more tanks are difficult to insert level senders in. Potential problems such as those listed below can easily be diagnosed by doing side by side comparisons between a calculated and physical tank.

- Leaks in the fuel system
- Uneven drain of interconnected tanks
- Malfunction of the level sender
- Malfunction of the flow sender

3.12.4.5 Single fuel flow only indicator

This mode is displayed if either fuel flow 1 or fuel flow 2 is selected and no fuel level senders are selected.



3.12.4.6 Dual fuel flow indicator

This mode is displayed if both fuel flow 1 and fuel flow 2 are selected and the fuel mode is selected for dual flow. Both fuel level senders are disabled.



3.12.4.7 Single tank level indicator

This mode is displayed if either fuel level 1 or fuel level 2 is selected. Both fuel flow senders are disabled.

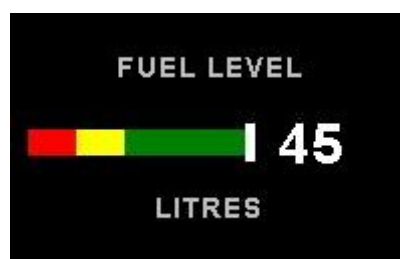

3.12.4.8 Dual tank level indicator

This mode is displayed if both fuel level 1 and fuel level 2 are selected. Both fuel flow senders are disabled.



3.12.4.9 Differential/Summed fuel flow

This mode is displayed if both fuel flow 1 and fuel flow 2 are selected and the fuel mode is selected for either differential or summed.



3.12.4.10 Calculated Fuel Tanks

Calculated fuel tanks will have the text "CALC" in the fuel bar to indicate that the fuel level is calculated from fuel flow and that it is not a physical measure of the fuel tank.



3.12.4.10 Fuel at Waypoint and GPS Fix Status

The Xtreme will display the fuel remaining at the waypoint once an active waypoint has been selected. The GPS fix status is located next to the fuel range. AQ=acquiring (Red text color), 2D=2D fix, 3D=3D fix.



3.12.5 EGT/CHT display section

The XTreme supports up to 12 thermocouples for EGTs/CHTs. The EGT/CHT section will automatically try and maximize the display area according to the number of EGTs/CHTs selected. The EGT/CHT parameters can be configured in the "EGT SETUP" and "CHT SETUP" menu.

The EGT/CHT number will highlight to the indicated the temperature value if "HIGHEST" is selected. The EGT highlight color is magenta, and the CHT color is cyan.

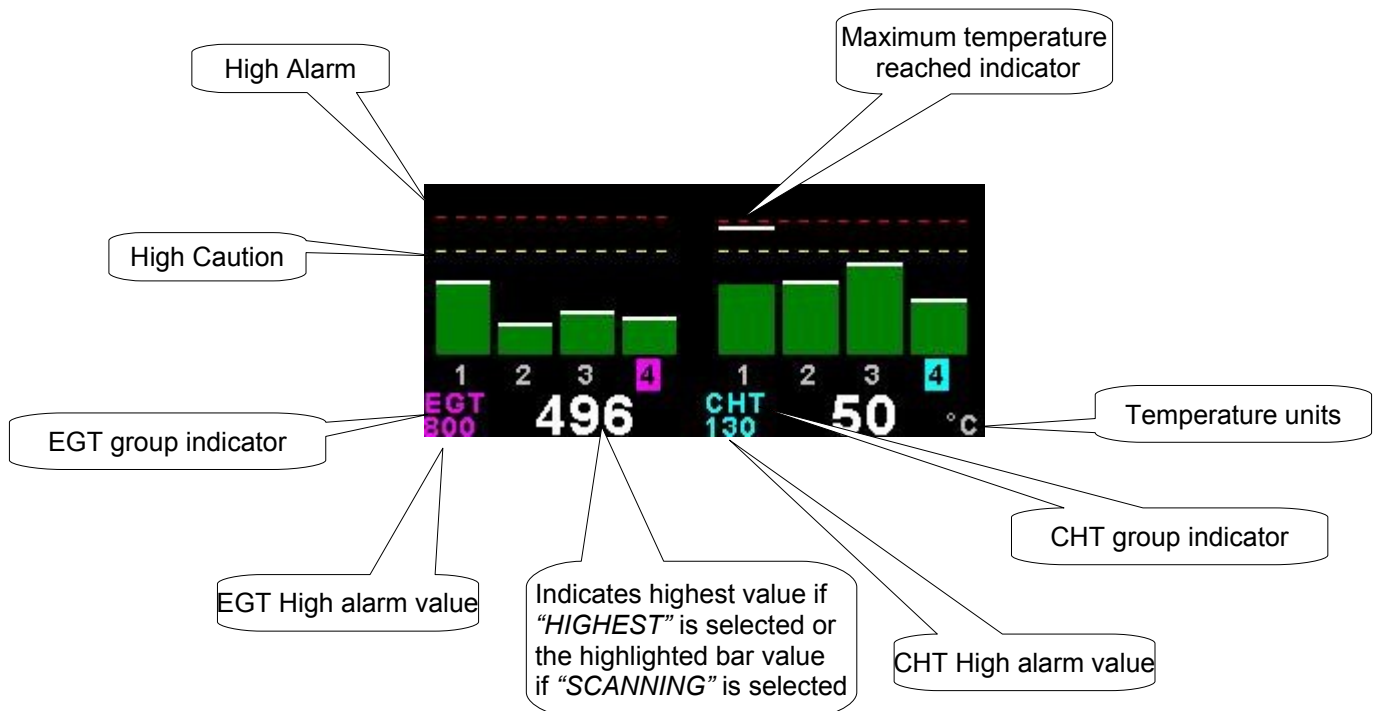

3.13 EMS Quick Select Menu System

- EXIT
- MARK WAYPT
- START FLIGHT
- FUEL REFILL
- LEAN MODE
- CRUISE MODE
- FUEL TOTALS
- TIMER
- MIN/MAX
- BACKLIGHT
- MENU

Press the rotary control when the EMS screen is displayed to access the EMS quick select menu.

MARK WAYPOINT:

See section 3.2 for more information.

START FLIGHT:

See section 3.2 for more information.

FUEL REFILL:

See section 3.5 for more information.

LEAN MODE:

EGT information is also very useful for fuel mixture control. As the fuel mixture is leaned, so the exhaust gasses get hotter. This rise in temperature is a sign of increased combustion efficiency as the optimum mixture setting is approached. If the leaning progresses past a certain point however, the temperature will begin to drop. This temperature drop is the result of reduced energy output from the diminished fuel flow. The best operating mixture for aircraft engines is in the vicinity of this peak EGT reading. The XTreme has a special Leaning mode, which easily identifies the peak EGT condition allowing you to adjust your fuel mixture for best performance. Fuel mixture should be adjusted once you have decided on a suitable cruise power setting (typically 70%). Once leaning mode has been enabled, the "LEAN MODE" label is displayed at the bottom left of the EMS display to clearly differentiate it from the normal operating mode. As the fuel mixture is slowly leaned past the point at which the temperature begins to drop (by more than 10°C/15°F), the absolute EGT temperatures will change to show the EGT reading relative to this peak. The sequential order as each cylinder peaks is also shown as numeric text under the cylinder. Leaning mode can be canceled by pressing the soft key to "OFF" or by changing the display screen.

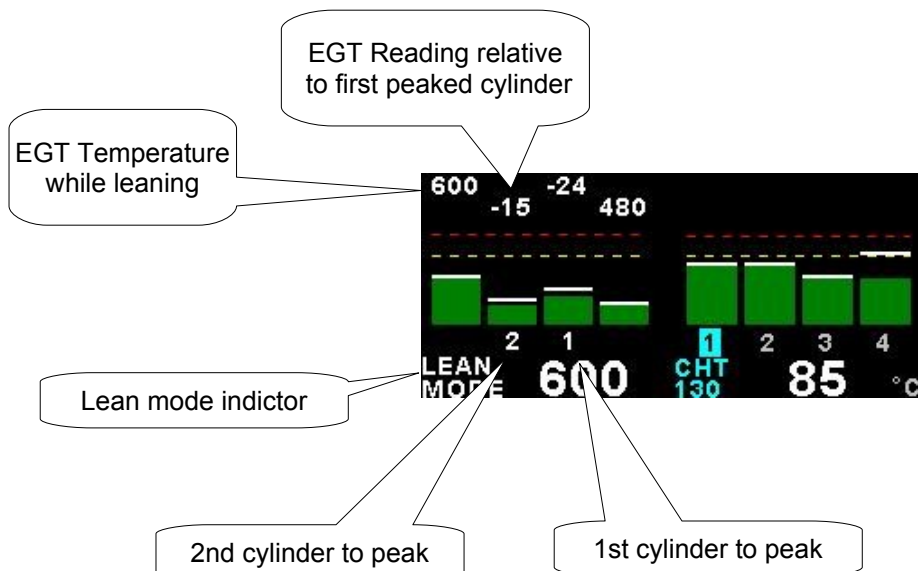

CRUISE MODE:

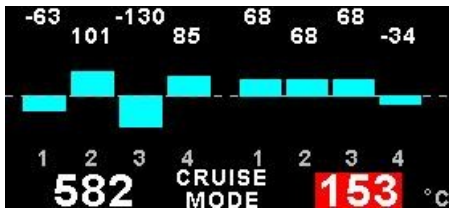

Once cruise mode has been enabled, the "CRUISE MODE" label is displayed at the bottom of the EMS display to clearly differentiate it from the normal operating mode. All EGT and CHT readings are immediately sampled as reference temperatures for the cruise. The display then shows EGT and CHT values relative to this reference temperature. Cruise mode can be canceled by pressing the soft key to "OFF".

FUEL TOTALS:

See section 3.5 for more information.

TIMER:

See section 3.2 for more information.

MIN/MAX:

See section 3.2 for more information.

BACKLIGHT:

See section 3.2 for more information.

MENU:

Select this menu option to enter the main menu system.

3.14 Electrical System Display

The electrical system page displays the electrical system/ECB (Electronic Circuit Breaker) information. The XTreme supports the Vertical Power VP-X electrical system / ECB unit.

Please note that the XTreme has only 1x RS232 serial port that can only have one piece of equipment connected to it. Equipment includes: serial altitude encoder, Electrical system (Vertical Power VP-X) and the CO Guardian carbon monoxide detector.



3.14.1 Message Window



This windows displays the status of the VP-X system.

3.14.2 System Power Window



This windows displays the main power values as reported by the VP-X system.

3.14.3 WIGWAG mode



This annunciator will indicate that the wigwag function has been activated on the VP-X system. Please see the Vertical Power VP-X documentation for further information.

3.14.4 Device Information



This window displays the highlighted devices name, circuit breaker current value, the current used by the device, status and location.



Use the rotary control to view the desired device. The Circular dot indicates the following:

- Green dot: Device is on and ok.
- White dot: Device is off.
- Red Dot: Device is in a fault condition.

The soft keys allow the user to manually turn on or off a device. If the device is in a fault condition, the ON/OFF soft keys are hidden and the RESET soft key is shown.

3.15 Electrical System Quick Select Menu System



Press the rotary control when the electrical system screen is shown to access the electrical system quick select menu.

WIG-WAG:



Select "AUTO" to activate the wigwag mode, or "STEADY" to cancel the wigwag mode. Please see the Vertical Power VP-X documentation for further information.

MARK WAYPOINT:

See section 3.2 for more information.

START FLIGHT:

See section 3.2 for more information.

MIN/MAX:

See section 3.2 for more information.

BACKLIGHT:

See section 3.2 for more information.

MENU:

Select this menu option to enter the main menu system.

3.16 GPS Display

The GPS page show the GPS information in an easy to read format. Sunrise/sunset times as well as the magnetic variation is shown.

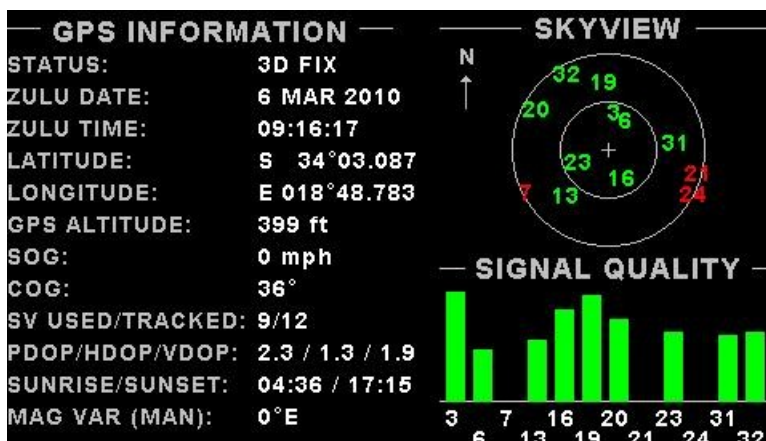

3.17 GPS Quick Select Menu System



Press the rotary control when the GPS screen is shown to access the GPS quick select menu.

MARK WAYPOINT:

See section 3.2 for more information.

START FLIGHT:

See section 3.2 for more information.

MIN/MAX:

See section 3.2 for more information.

BACKLIGHT:

See section 3.2 for more information.

MENU:

Select this menu option to enter the main menu system.

3.18 Information/Checklist Display

The Information/Checklist page shows checklists and graphic information pages which are loadable from the SD card.

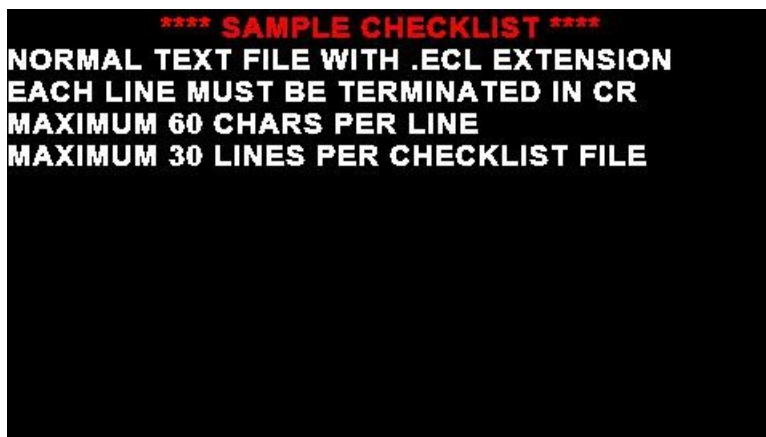

3.18.1 Graphic information pages

The graphic information page allows you to display any type of image on the XTremes high resolution graphics display.

Creating your own graphic information pages

You will need:

- A bitmap picture of your choice (*.BMP, 480x272 pixel resolution)
- The Enigma BMP to MIF converter tool (can be downloaded free of charge from <http://www.mglavionics.co.za> or can be found on the XTreme distribution SD card).

The Enigma BMP to MIF program is used to convert images in Windows BMP format to Enigma MIF format. You can use this program to make your own startup screen (Splash screen) and graphic information pages. The color depth is limited to Enigmas 256 colors.

Run the Enigma BMP image to MIF format converter program.

Load an image file (and remember the location), select the resolution as width (480) and height (272) and press the process button. The new MIF image will be located in the same directory as the source (.BMP) file. Copy the created file (.MIF extension) to the Infopage directory on the SD card.

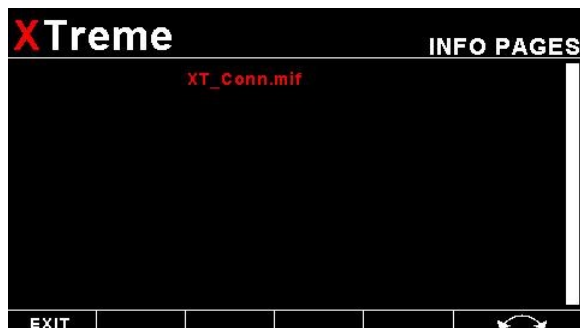

The graphic information file can then be loaded by pressing the rotary control and selecting "INFO PAGES". A window containing all the files with the .MIF extension is shown. Select the desired information page. The number of information pages that can be stored and displayed depends on the size of the SD card.

3.18.2 Checklists

A checklist file is simply a text file created in a word processing program and saved with a .ECL extension. The name of the file does not matter but we suggest calling it something familiar so you can easily identify it. The length of each text line must not be more then 60 characters and must be terminated with an Enter (CR). The line will automatically be truncated at the end of the right hand side of the screen. Each checklist file must not be more then 30 lines.



Copy the created file (.ECL extension) to the checklst directory on the SD card when you are complete. The checklist file can be loaded by pressing the rotary control and selecting “CHECKLISTS”. A window containing all the files with the .ECL extension will shown. Select the checklist you require. The number of checklists that can be stored and displayed depends on the size of the SD card.

3.19 Information/Checklist Quick Select Menu System



Press the rotary control when the Info/Checklist screen is shown to access the Info/checklist quick select menu.

MARK WAYPOINT:

See section 3.2 for more information.

START FLIGHT:

See section 3.2 for more information.

INFO PAGES:

This menu option selects a graphic information page to display. A window will open displaying all the files with the .MIF extension in the Infopage directory on the SD card. Press the rotary control over the file you wish to load as a graphic information page.

CHECKLISTS:

This menu option selects a checklist to display. A window will open displaying all the files with the .XCL extension in the Checklst directory on the SD card. Press the rotary control over the file you wish to load as a checklist.

MIN/MAX:

See section 3.2 for more information.

BACKLIGHT:

See section 3.2 for more information.

MENU:

Select this menu option to enter the main menu system.

3.20 Waypoints

The XTreme has 2 databases that it uses for waypoints. A “NAVIDATA” and a user “SUPPLEMENTARY” database.

The Navidata database is compiled by the MGL Central application. There are precompiled navidata databases for most countries on the XTreme distribution SD Card and also from various MGL websites. Alternatively Waypoint and airport data can be obtained for many areas of the world through the free service provided at www.navaid.com web site. Download data for your region in GPX format. This can be imported into the MGL Central application. Please note that the navidata database must be in a version 5 format and must not be encrypted. If you are unsure of the version then import the navidata file into the latest version of the MGL central application and then re-export it again. THE NAVIDATA.EWD FILE MUST RESIDE IN THE ROOT DIRECTORY OF THE SD CARD.

The user “Supplementary” database is the database that can be created and edited on the Xtreme using the waypoint menu or in the MGL central application. The file must be called waypoint.ewd and it must RESIDE IN THE ROOT DIRECTORY OF THE SD CARD. Waypoints that are created using the mark function in the quick select menu are saved in this database.

Press the 2nd most left softkey during the normal display screens to access the waypoint selection screen. The following screen will be displayed:

The screenshot shows the 'WAYPOINTS GOTO/NEAREST' screen on the XTreme. The screen displays a list of waypoints with their identifiers, names, and distances. Callouts provide additional information:

- N:** Waypoint is in the navidata database.
- W:** Waypoint is in the supplemental database.
- Distance to waypoint from the current location.
- 6 Character short Waypoint name.
- Long Waypoint name.
- Page up and Page down softkeys.
- Scroll up and down through the waypoint list.

Identifier	Waypoint Name	Distance
N STRFTN	Strandfontein	68sm
N ZA0092	Holrivier Airport,SF	73sm
N HOLGAT	Holgat	73sm
N VREDDL	Vredendal Old Airfield	80sm
N FAVR	Vredendal	83sm
N ZA-KIG	Koingnaas Airport,SF	85sm
N KOOING	Koingnaas	85sm
N VANRYN	Van Rhynsdorp	95sm
N CLANWM	Clanwilliam	113sm
N FACW	Clanwilliam Airport,SF	114sm
N FASD	Saldanha	116sm

The nearest 100 waypoints to your current location is displayed.

Searching Waypoints:

Press the search waypoint to search the navigation databases if the required waypoint is not in the list. The following screen is displayed:



Use the rotary control to enter the search string for the short name. Once the required waypoint is visible in the list press the "LIST" softkey. Use the rotary control to scroll up and down the list. Press the rotary control to select the required waypoint.

3.21 Routes

The XTreme has the ability to fly preset routes. Press the middle softkey during the normal display screens to access the route selection screen. The following screen will be displayed:

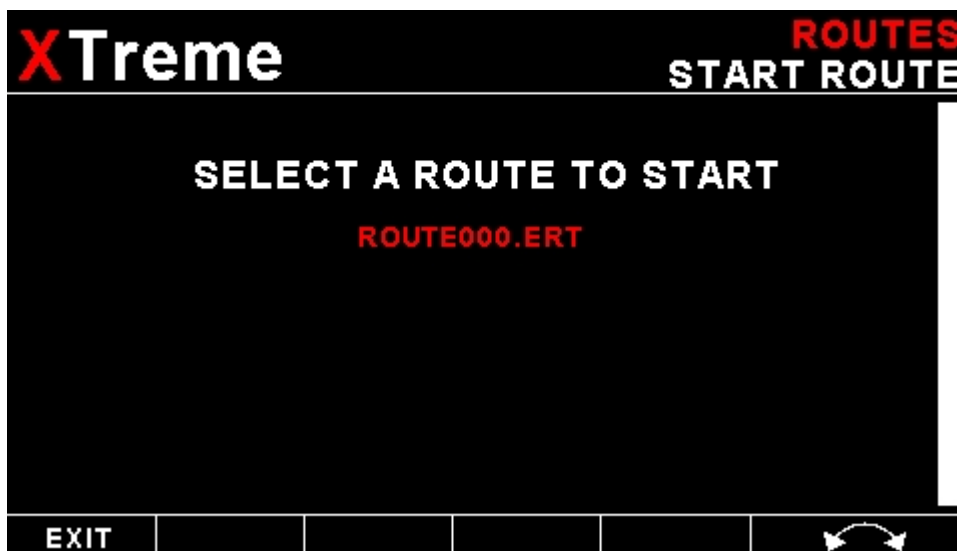

Once a route has been selected then select the route flying direction

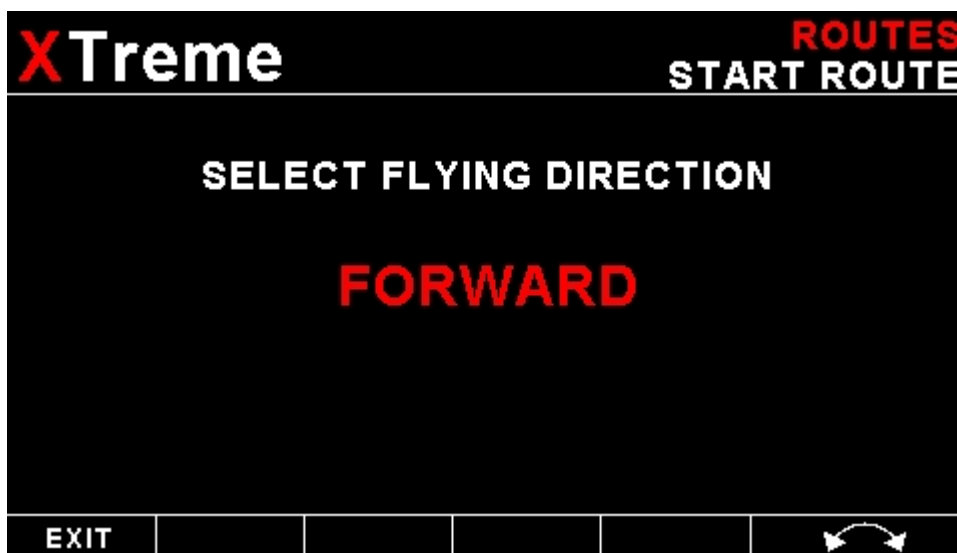

The first or last waypoint will be selected depending on which direction was selected.

If the middle softkey is pressed again when a route is active then the following screen will be displayed.



A new waypoint in the route can be selected, the flying direction can be changed or the route can be canceled.

4 Main Menu System

- EXIT
- MARK WAYPT
- START FLIGHT
- REALIGN AHRS
- LEVEL PITCH
- ALTITUDE BUG
- HEADING BUG
- TIMER
- MIN/MAX
- BACKLIGHT
- MENU**

To access the main menu system, press the rotary control knob, scroll down to the "MENU" option and press the rotary control knob again. Use the rotary control to navigate through the menu system.

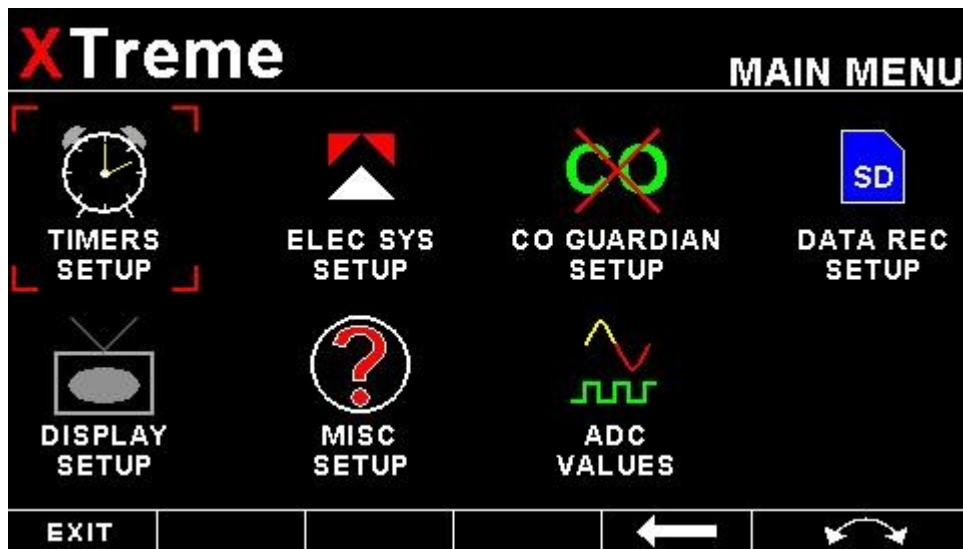
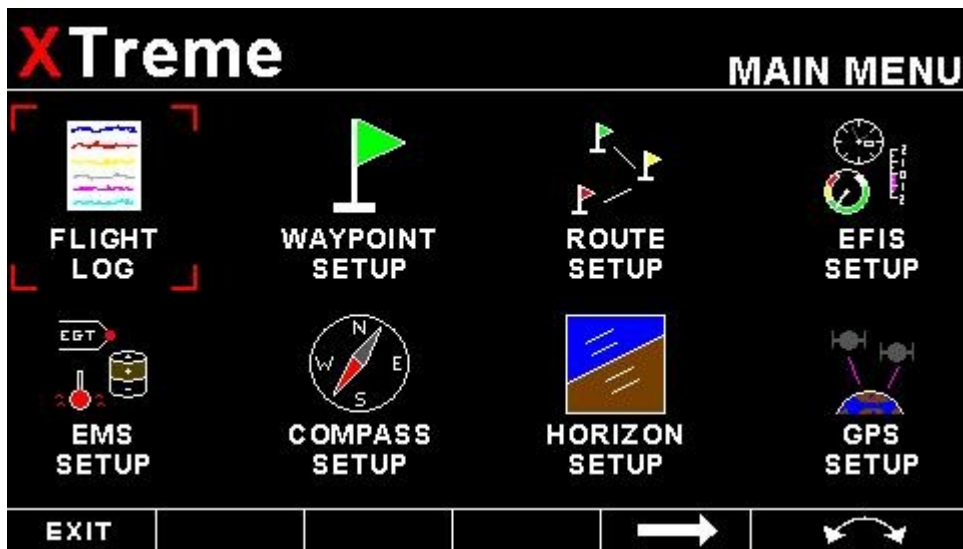

4.1 Menu Sub-Bar



Use the menu sub-bar for quick menu navigation. Select the soft key directly under the text to activate that function.



4.2 Flight Log

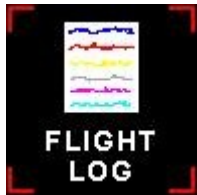

EXPORT FLIGHT LOG TO SD CARD:

Use this function to export the current flight logs stored in the XTreme to a SD card. The exported filename is FLTLOG.LOG. The exported flight log can then be imported into the MGL Avionics Enigma Flight Planner software for editing and printing. Please see the Enigma Flight Planner software for further information.

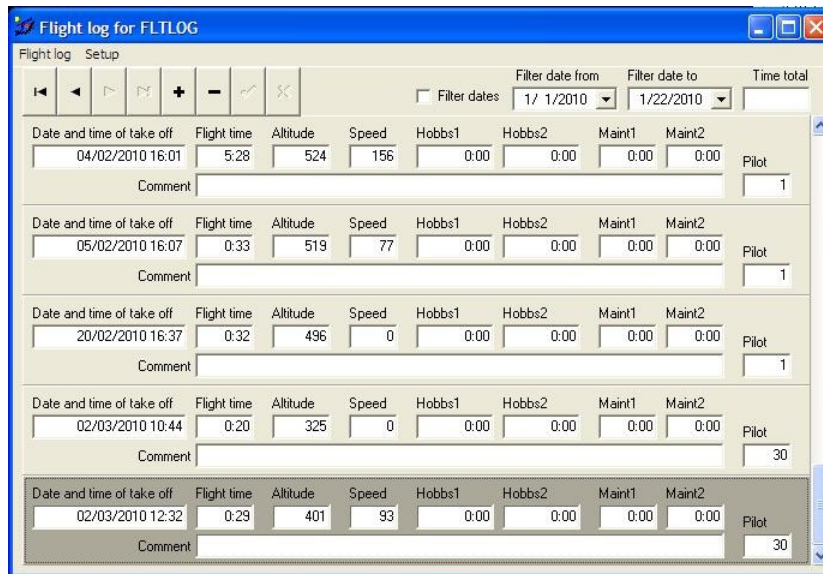

VIEW FLIGHT LOG:

This allows the pilot to view the last 1000 recorded flights.

ERASE FLIGHT LOG:

Use this function to erase the current flight log stored in the XTreme.

PILOT NUMBER:

Select a pilot number under which the next flights will be logged. Every flight entry in the flight log has a pilot number associated to it.

EFIS FLIGHT TIMER DISPLAY:

This enables or disables the flight timer display on the EFIS and MFD displays.

FLIGHT DETECT:

Select if you want the flight log to automatically “*AUTOMATIC*” start or if you want to manually “*MANUAL*” start and stop it.

The XTreme uses the following algorithm to determine if a flight is in progress (“*AUTOMATIC*” mode): If the airspeed is greater than the preset “*FLIGHT DETECT MINIMUM ASI*” value or the RPM is greater than the preset “*FLIGHT DETECT MINIMUM RPM*” value for a duration of 60 seconds or more, a flight is started with a logbook entry. The flight ends if airspeed or RPM falls below the preset value for 30 seconds.

The above algorithm ensures that touch-and-goes will not result in the end of a flight and a logbook entry. Should the instrument be switched off during a flight, this will end the flight and the log will reflect the time until the instrument was switched off. Should the instrument be switched on again during a flight, a new flight will start for logging purposes

FLIGHT DETECT MINIMUM RPM: (Automatic mode only)

Enter the minimum RPM threshold that will start a new flight log entry.

FLIGHT DETECT MINIMUM ASI: (Automatic mode only)

Enter the minimum ASI threshold that will start a new flight log entry.

4.3 Waypoint Setup

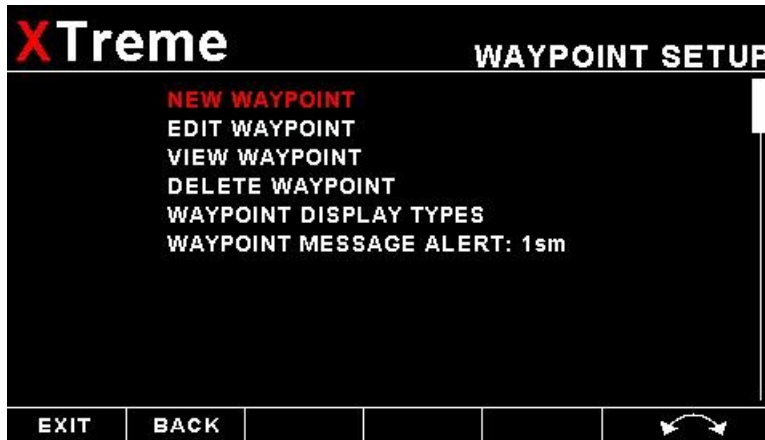

The waypoint setup allows the pilot to edit the supplementary waypoint database.

NEW WAYPOINT:

Select this menu option to create a new waypoint.

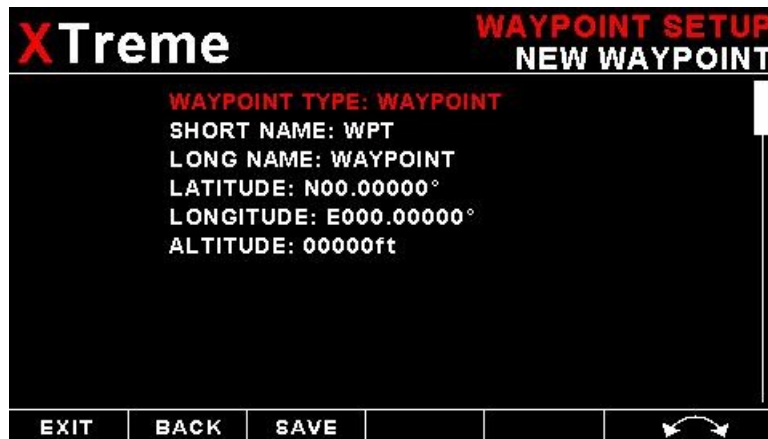

EDIT WAYPOINT:

Select this menu option to edit a waypoint.

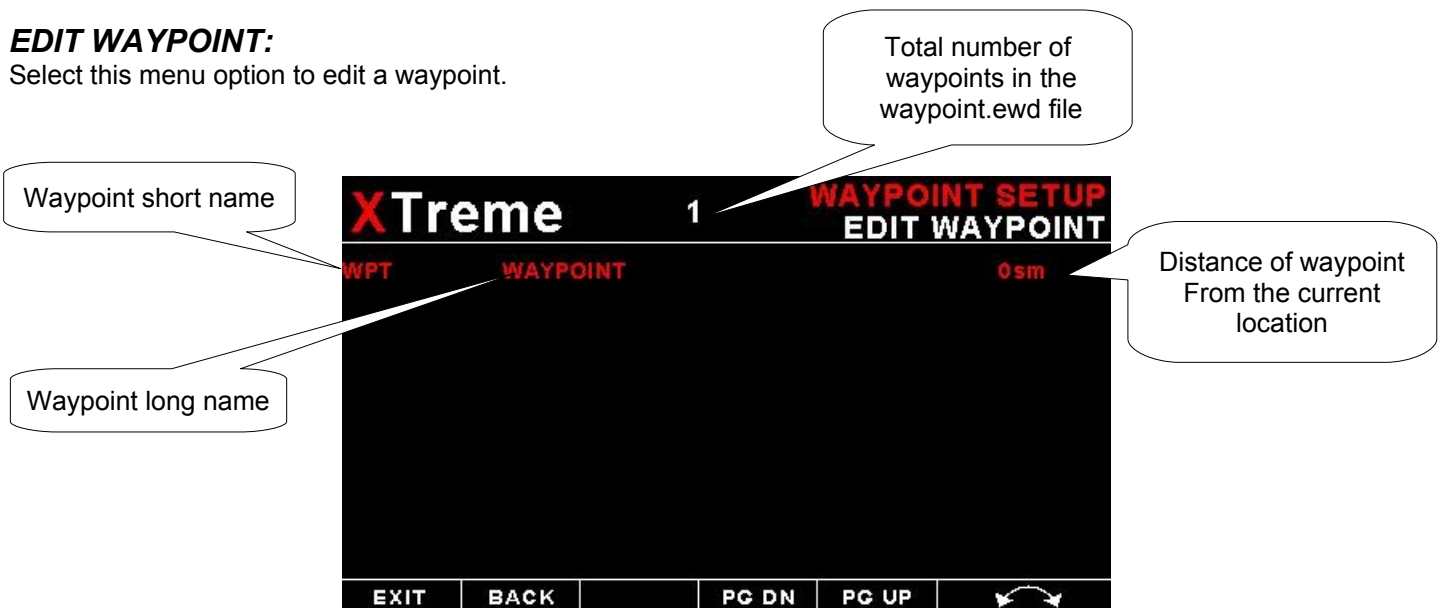

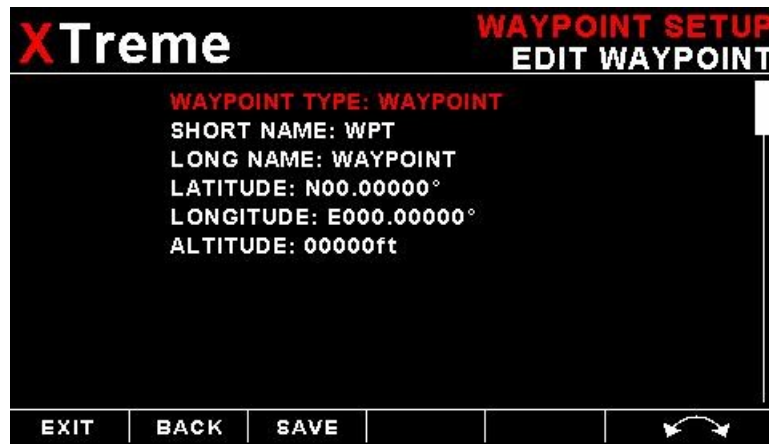

VIEW WAYPOINT:

Select this menu option to view a waypoint.

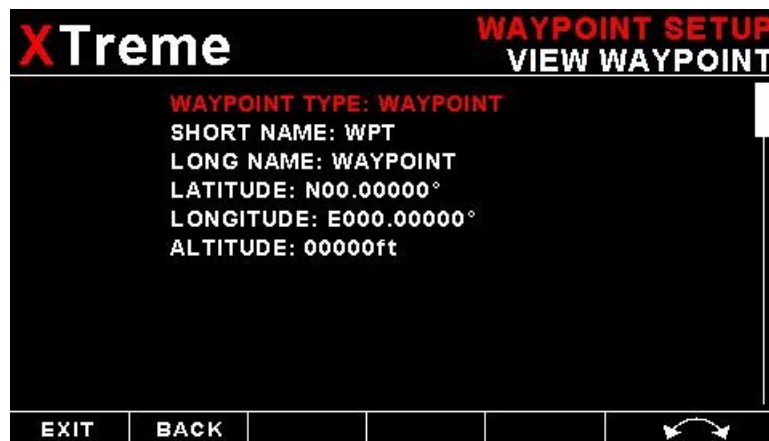
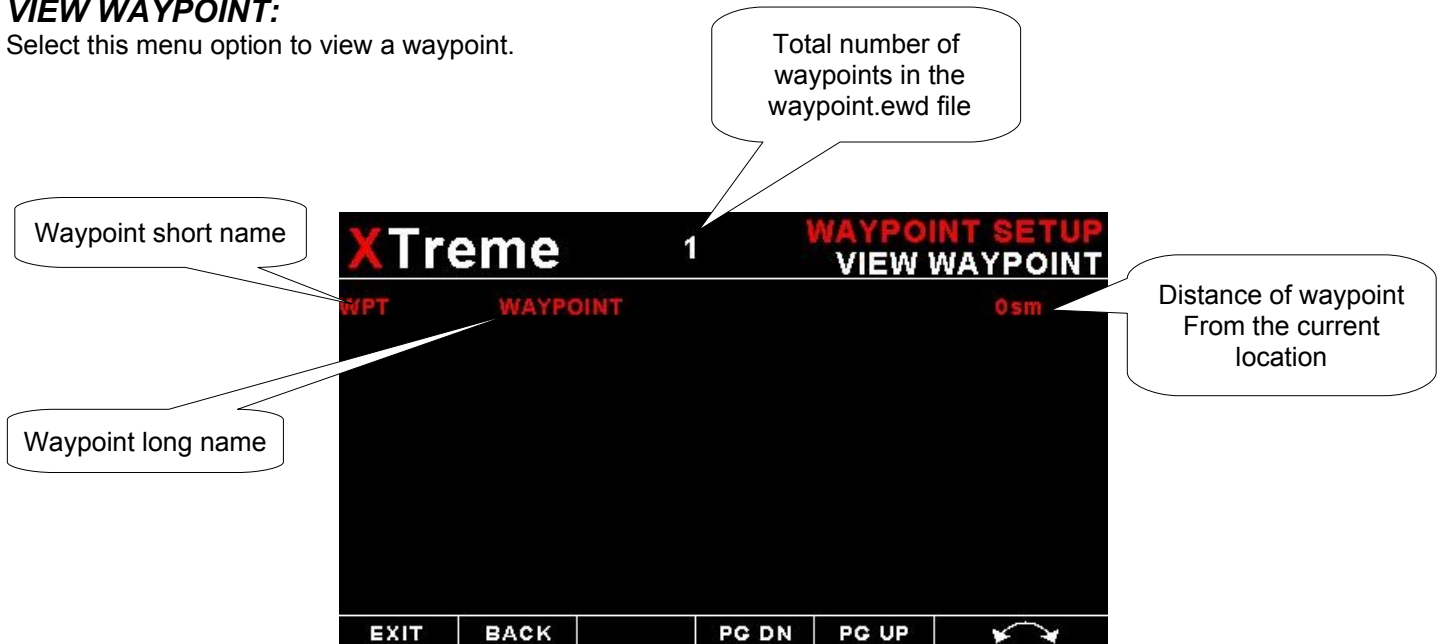

DELETE WAYPOINT:

Select this menu option to delete a waypoint.



WAYPOINT DISPLAY TYPES:

Select what type of waypoints to display when browsing/searching the navidata file. Selecting only the waypoint types of interest can speed up the database searching considerably.



WAYPOINT MESSAGE ALERT:

Enter the distance to the waypoint when the waypoint alert message must be displayed.

4.4 Route Setup



NEW ROUTE:

Select this menu option to create a new route. A file with the route name and the extension .ert will be created. It will be created in the root directory of the SD card.



ADD/INSERT WAYPOINT TO ROUTE:

Select this menu option to add a waypoint to a route.



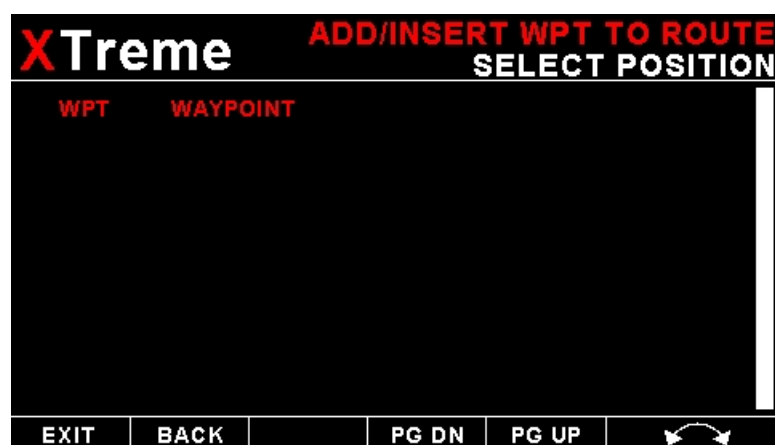
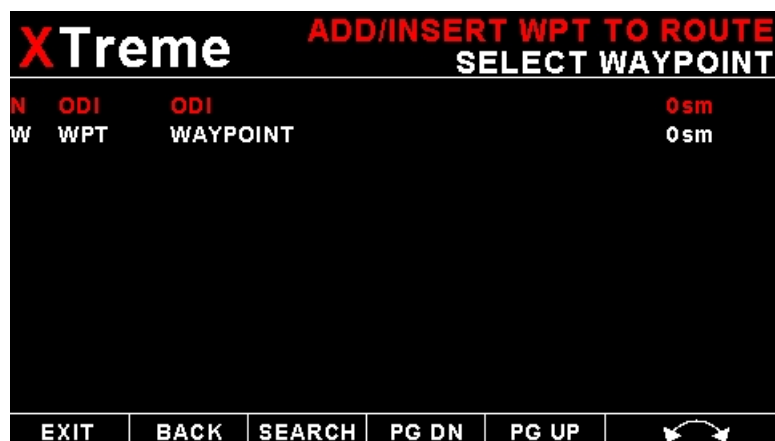

REMOVE WAYPOINT FROM ROUTE:
Select this menu option to remove a waypoint from a route.



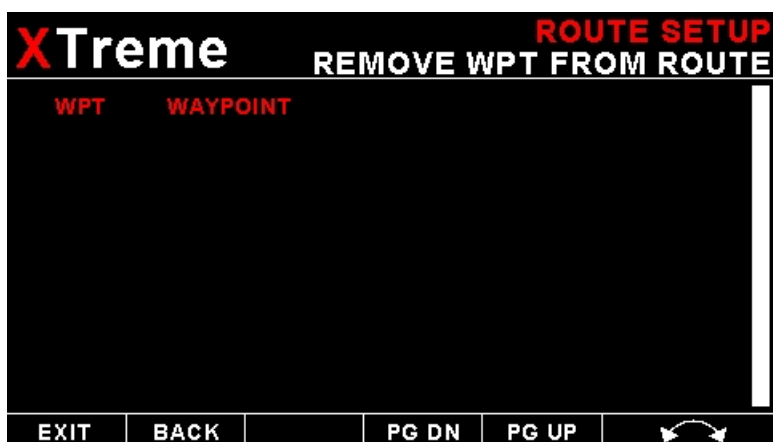

VIEW ROUTE:

Select this menu option to view all the waypoints in a route.

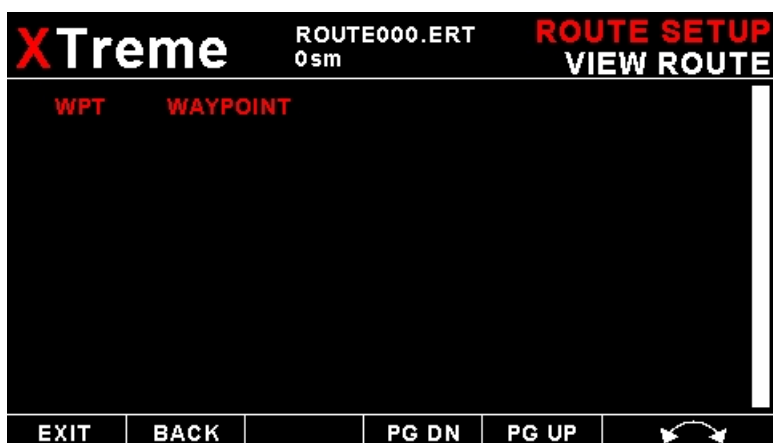

EDIT ROUTE NAME:

Select this menu option to edit the route name.

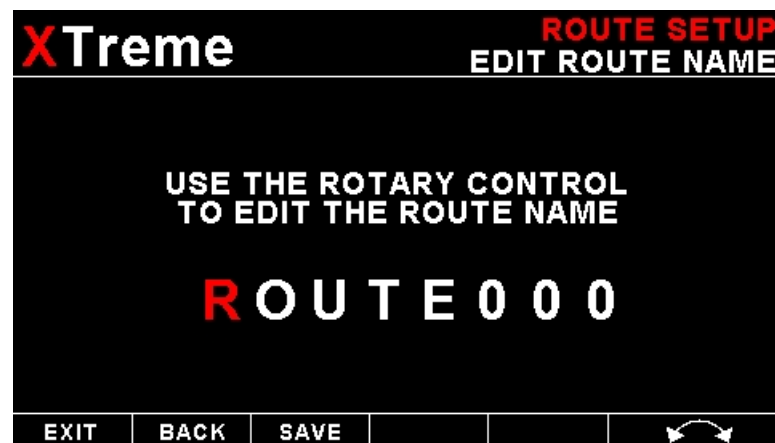

DELETE ROUTE:

Select this menu option to delete a route.

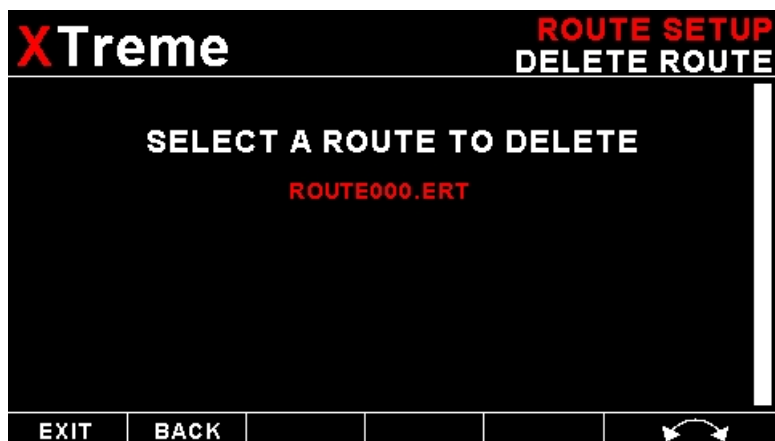

4.5 EFIS Setup

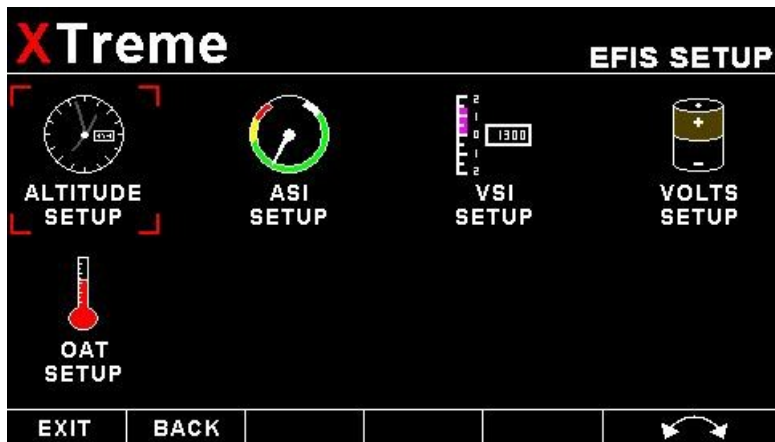

4.5.1 Altitude Setup

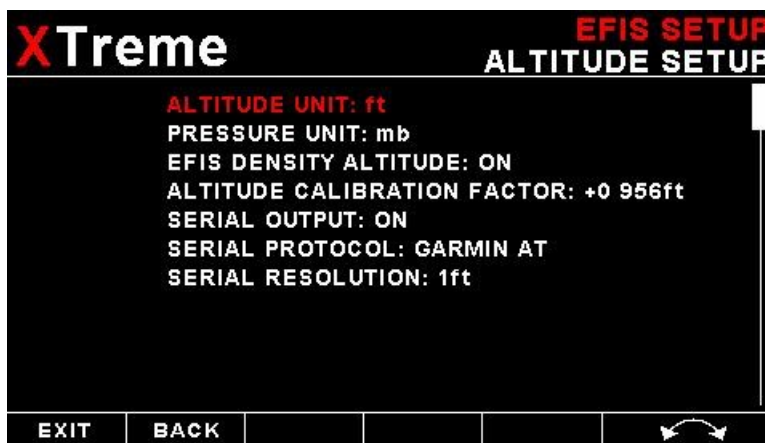

ALTITUDE UNIT:

Select if you want the altitude displayed in ft (feet) or m (meters).

PRESSURE UNIT:

Select if you want the local pressure displayed in mB (millibars) or “Hg (inches of mercury).

EFIS DENSITY ALTITUDE:

This enables or disables the density altitude diisplay on the EFIS and MFD displays.

ALTITUDE CALIBRATION FACTOR:

On the rear of your XTreme instrument you will find the calibration factor that has been determined to ensure the most accurate reading of your altimeter. This is the value that should be entered here. Should you have access to an accurate reference you may use this function to calibrate your altimeter. Before you do this, ensure that your calibrated and certified reference is set to the local pressure of 1013.25mB (29.92”HG). Your altimeter has been calibrated by the factory to an accuracy of +/- one mB or approximately +/- 30 ft (10m) at sea level.

SERIAL OUTPUT:

Select “ON” to enable the RS232 serial altitude output. This formatted serial RS232 message can be directly interfaced to various RS232 serial input transponders. If a parallel Gillham output is required then a CNV-ALT2 can be purchased from your MGL Avionics distributor to convert the RS232 output to a parallel Gillham output. The RS232 is output on PIN 7 (RS232 port 1 TXD)

SERIAL PROTOCOL:

Select the protocol of the serial RS232 output message. The protocol can be selected between GARMIN AT, Magellan, Northstar/Garmin, Trimble/Garmin, MGL Avionics and Microair UAV. Please note that the baud rate is automatically adjusted according to which protocol is selected. The output format is as follows. The message contains the current pressure altitude with a fixed reference to 1013.25mB (29.92 inches mercury). All protocols use 8 databits, no parity, and 1 stop bit. The message is outputted once a second.

Protocol	Baud Rate	Message format	Example
Garmin AT	1200	#AL, space, +/-, five altitude digits right justified zero padded, T+25, checksum, carriage return The checksum is a simple modulo 256 sum of the binary values of the individual characters. The checksum is sent as two	#AL +02372T+25DF[CR]

		characters in hexadecimal format	
Magellan	1200	#MGL, +/-, five altitude digits right justified zero padded, T+25, checksum, carriage return The checksum is a simple modulo 256 sum of the binary values of the individual characters. The checksum is sent as two characters in hexadecimal format	\$MGL+02372T+2513[CR]
Northstar, Garmin	4800	ALT, space, five altitude digits right justified zero padded, carriage return	ALT 02372[CR]
Trimble, Garmin	9600	ALT, space, five altitude digits right justified zero padded, carriage return	ALT 02372[CR]
MGL Avionics	9600	ALT, +/-, five altitude digits right justified zero padded ,1013.25mB (29.92”Hg) referenced, C, +/-, five altitude digits right justified zero padded (corrected to local pressure), L, local pressure setting in millibars,+/-, four digit VSI reading right justified zero padded in ft/min, X, checksum, carriage return The checksum is a simple modulo 256 sum of the binary values of the individual characters. The checksum is sent as two characters in hexadecimal format	ALT+02372C+02372L1013+0000XCA[CR]
Microair UAV	9600	STX,a,=, five altitude digits right justified zero padded, ETX	[STX]a=02372[ETX]
STX=0x02 ETX=0x03 CR=0x0D			

SERIAL RESOLUTION:

Select the resolution of the output altitude data, a selection of 1,10,25 or 100 ft can be selected.

Please note that the XTreme has only 1x RS232 serial port that can only have one piece of equipment connected to it. Equipment includes: serial altitude encoder, Electrical system (Vertical Power VP-X) and the CO Guardian carbon monoxide detector.

4.5.2 Airspeed Setup

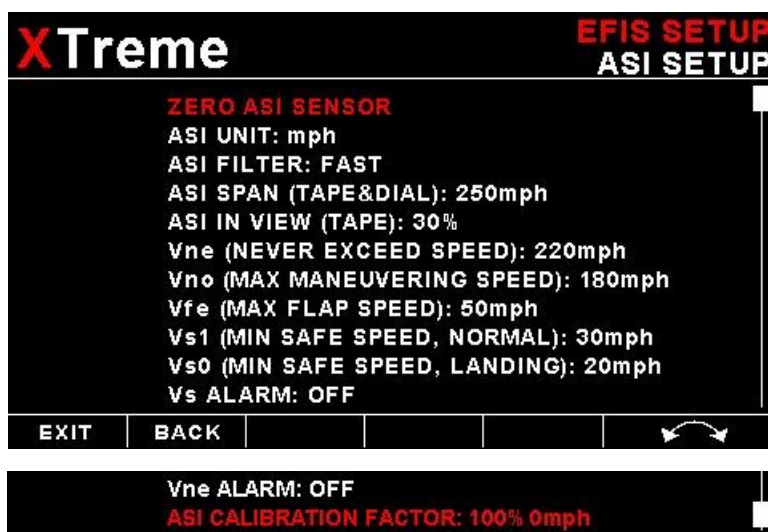

ZERO ASI SENSOR:



This setup allows your instrument to measure the zero airspeed reading of the airspeed sensor and set a calibration value internally for this. This is equivalent to some mechanical airspeed indicators that have an adjustment to set the needle to zero when the aircraft is not moving. You would use this function occasionally if you see an airspeed reading when the aircraft is at rest. This may be caused by aging of the built in pressure sensor or related electronics. When this function is performed make sure that there is no air flow into the pitot tube as this would result in an incorrect internal calibration.

ASI UNIT:

Select if you want the ASI to be displayed in mph (statute miles per hour), km/h (kilometers per hour) or kts (nautical miles per hour).

ASI FILTER:

This function can be used to select the signal filter time constant. Selections are "NONE", "FAST" or "SLOW". This selection influences the rate at which your ASI can change its reading. If you have an installation that suffers from strong turbulence at the pitot tube, select "slow". If you have a very clean airflow in front of the pilot tube you can select "fast" which will give you a faster response to airspeed changes.

ASI SPAN (TAPE&DIAL):

Select the maximum value that you want the airspeed tape & dial displays to show. This can give you increased display resolution.

ASI IN VIEW (TAPE):

Adjust this setting to set the amount of tape to view. For example, setting this value to 30% and your "ASI SPAN" to 250 will result in the tape showing 75 on the display at a time.

Vne (MAX EXCEED SPEED):

Enter your maximum speed your aircraft should not exceed.

Vno (MAX MANEUVERING SPEED):

Enter your maximum maneuvering speed.

Vfe (MAX FLAP SPEED):

Enter the maximum speed that is permissible with the flaps extended.

Vs1 (MIN SAFE SPEED, NORMAL):

Enter your minimum safe speed for normal flight of your aircraft

Vso (MIN SAFE SPEED, LANDING):

Enter your minimum safe speed for landing your aircraft

Vs ALARM:

This enables or disables Vs Alarm

Vne ALARM:

This enables or disables the VNE alarm.

ASI CALIBRATION FACTOR:

During the factory calibration a factor has been determined and entered here that will give you accurate airspeed, provided your pitot tube is not influenced by pressure effects caused by airflow around your airframe. The calibration is displayed in % of the reading, you can increase or decrease the reading if required to help cancel out under or over reading of the airspeed indicator on your aircraft. The original calibration factor has been written onto the back of your XTreme instrument.

4.5.3 VSI Setup

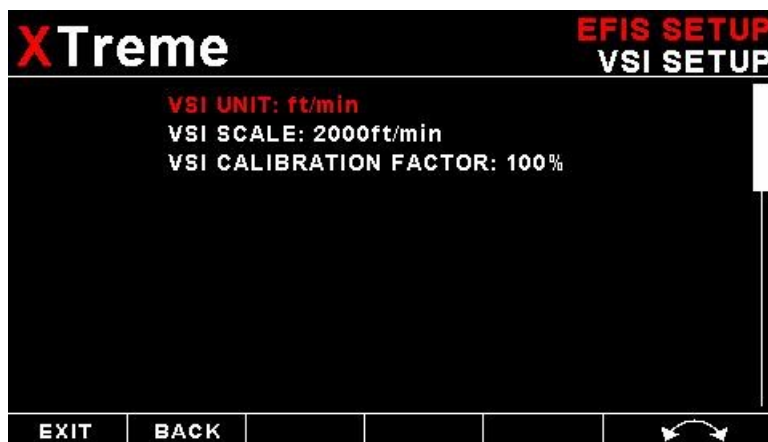
**VSI UNIT:**

Select if you want the VSI to be displayed in "*ft/min*" (feet/minute) or "*m/s*" (meters/second).

VSI SCALE:

Select the VSI scale most suited for your aircraft.

VSI CALIBRATION FACTOR:

This is a function that is used to calibrate your VSI to read exact rates of climb or decent. This function works as a percentage of initial reading. The default setting for this function is 100%. Increasing this value increases the VSI reading and decreasing the value decreases the reading.

Suggested VSI calibration method

After you have installed the instrument, perform a calibration flight. This should be done in very calm conditions. Turbulence and thermal activity will make accurate calibration impossible. Many areas have ideal conditions during early mornings or late afternoons. Place the instrument in ft/min for ease of calibration. Take your aircraft to a few thousand feet above ground and start a glide with a low power setting. Take a stopwatch and when the glide is stable (stable VSI reading) start the stopwatch. Take note of your altimeter reading at the same time. Continue the stable glide for one minute exactly. After the minute has finished, take another reading of your altimeter.

Example:

VSI reading during stable glide: -400 ft/min

Start altitude: 2500 ft.

End altitude: 2050 ft.

In the above example the VSI is under reading by about 12%. Set your VSI calibration to 112% to cancel out the error.

4.5.4 Volts Setup

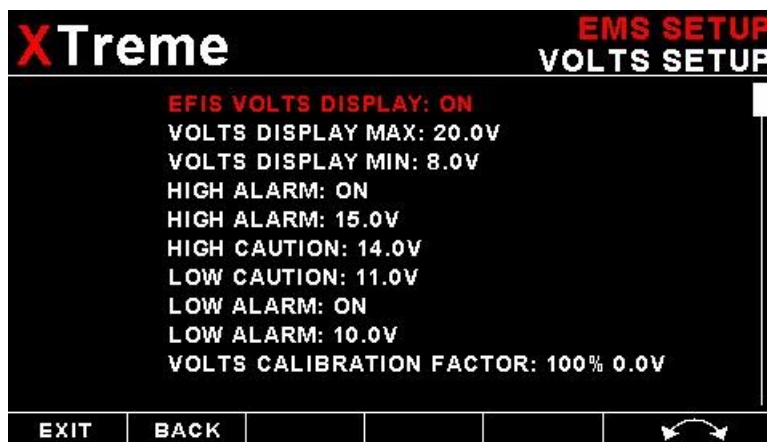

EFIS VOLTS DISPLAY:

This enables or disables the volts display on the EFIS and MFD displays.

VOLTS DISPLAY MAX:

Select the maximum value that you want the volts bargraph in the EMS display to show. This can give you increased display resolution.

VOLTS DISPLAY MIN:

Select the minimum value that you want the volts bargraph in the EMS display to show. This can give you increased display resolution.

HIGH ALARM:

This enables or disables the volts high alarm.

HIGH ALARM:

Enter the voltage threshold for when the high alarm must be activated. Any voltage above this value will activate the alarm.

HIGH CAUTION:

Enter the voltage for the high caution. This is the lower value of the upper yellow band.

LOW CAUTION:

Enter the voltage for the low caution. This is the upper value of the lower yellow band.

LOW ALARM:

This enables or disables the volts low alarm.

LOW ALARM:

Enter the voltage threshold for when the low alarm must be activated. Any voltage below this value will activate the alarm.

VOLTS CALIBRATION FACTOR:

During the factory calibration a factor has been determined and entered here that will give you an accurate volts reading. If you would like to adjust this value then measure the supply voltage with a multimeter and adjust the calibration factor until the Xtreme matches that of the multimeter.

4.5.5 OAT Setup

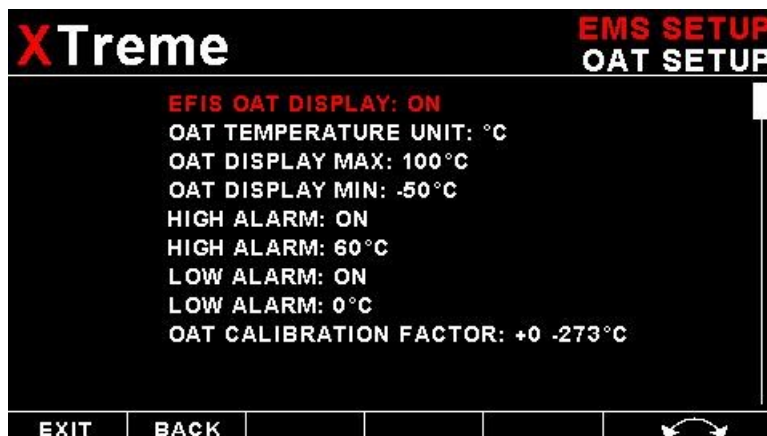

EFIS OAT DISPLAY:

This enables or disables the OAT display on the EFIS and MFD displays.

OAT DISPLAY MAX:

Select the maximum temperature that you want the OAT bargraph in the EMS display to show. This can give you increased display resolution.

OAT DISPLAY MIN:

Select the minimum temperature that you want the OAT bargraph in the EMS display to show. This can give you increased display resolution.

HIGH ALARM:

This enables or disables the OAT high alarm.

HIGH ALARM:

Enter the temperature threshold for when the high alarm must be activated. Any temperature above this value will activate the alarm.

HIGH CAUTION:

Enter the temperature for the high caution. This is the lower value of the upper yellow band.

LOW CAUTION:

Enter the temperature for the low caution. This is the upper value of the lower yellow band.

LOW ALARM:

This enables or disables the OAT low alarm.

LOW ALARM:

Enter the temperature threshold for when the low alarm must be activated. Any temperature below this value will activate the alarm.

OAT TEMPERATURE UNIT:

Select whether you want the OAT to be displayed in degrees Celsius (°C) or in degrees Fahrenheit (°F).

OAT CALIBRATION FACTOR:

During the factory calibration a factor has been determined and entered here that will give you an accurate OAT reading. If you find this value is incorrect then adjust the calibration factor until the XTremes OAT matches that of a precision thermometer. Calibration can only be done in Celcius (°C).

4.6 EMS Setup

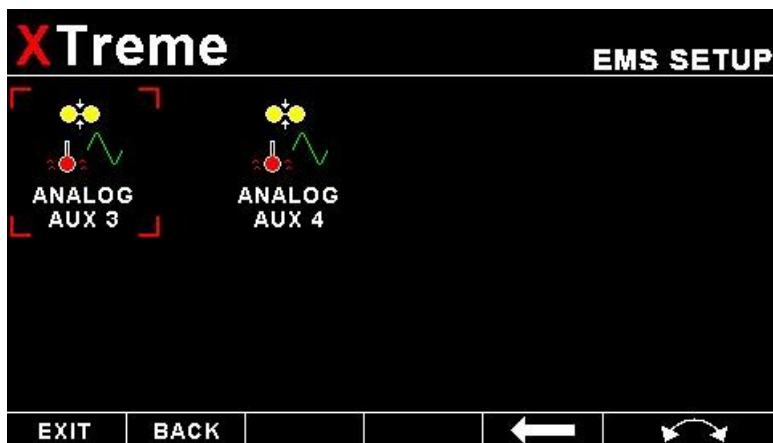
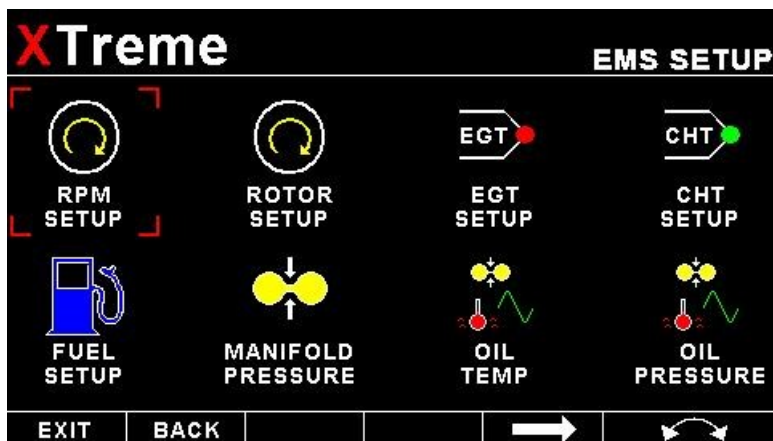

4.6.1 RPM Setup

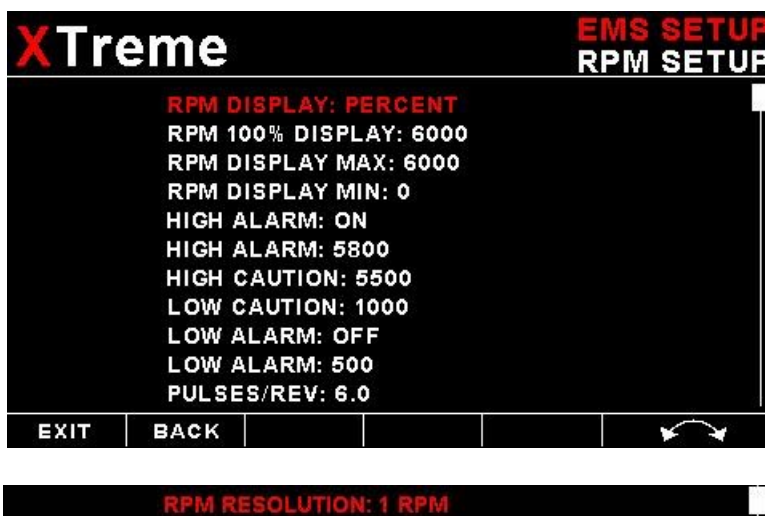

RPM DISPLAY:

Select if you want the RPM to be displayed in “RPM” or “PERCENT”. If you do not want any RPM information then set this parameter to “OFF”. If the rotor RPM is set to “RPM” or “PERCENT” then the engine RPM display will automatically be enabled.

RPM 100% DISPLAY:

Select the maximum value that you want the RPM to correlate to 100%.

RPM DISPLAY MAX:

Select the maximum RPM that you want the RPM dial to show. This can give you increased display resolution.

RPM DISPLAY MIN:

Select the minimum RPM that you want the RPM dial to show. This can give you increased display resolution.

HIGH ALARM:

This enables or disables the RPM high alarm.

HIGH ALARM:

Enter the RPM threshold for when the high alarm must be activated. Any RPM value above this value will activate the alarm.

HIGH CAUTION:

Enter the RPM value for the high caution. This is the lower value of the upper yellow band.

LOW CAUTION:

Enter the RPM value for the low caution. This is the upper value of the lower yellow band.

LOW ALARM:

This enables or disables the RPM low alarm.

LOW ALARM:

Enter the RPM threshold for when the low alarm must be activated. Any RPM value below this value will activate the alarm.

PULSES/REV:

Enter the number of pulses per RPM. For engines with an uneven number of cylinders like three cylinder four stroke engines you can enter values containing fractions (usually 1.5 in this example). Most four stroke engines would generate one pulse for every two revolutions per cylinder. A four cylinder automotive four stroke engine would thus generate 2 pulses per revolution. A typical Rotax DCDI two stroke engine would generate 6 pulses per revolution. The well known Rotax 912/914 engine generates one pulse per revolution.

RPM RESOLUTION:

Select the step size between successive RPM values eg. if the RPM value is 4003 RPM and the "RPM RESOLUTION" is 5 then the actual value shown is 4005 RPM.

4.6.2 Rotor Setup

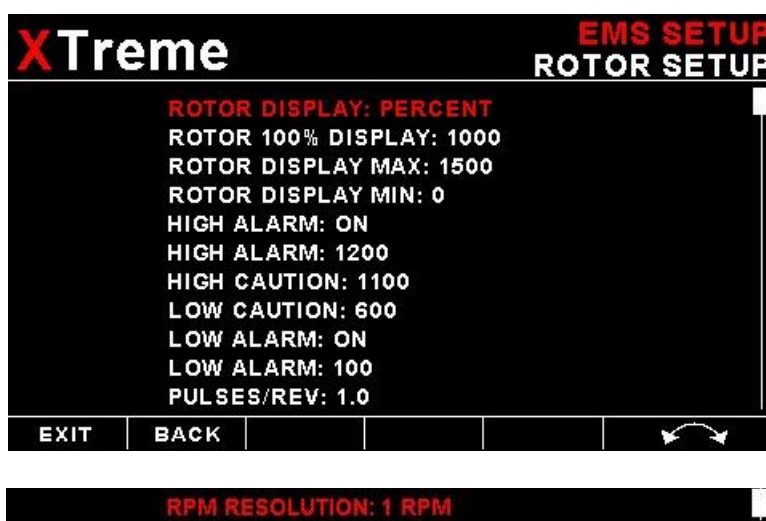
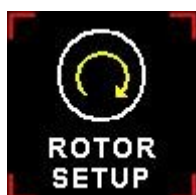

ROTOR DISPLAY:

Select if you want the rotor RPM to be displayed in "RPM" or "PERCENT". If you do not want any rotor RPM information then set this parameter to off. If the rotor RPM is set to "RPM" or "PERCENT" then the engine RPM display will automatically be enabled.

ROTOR 100% DISPLAY:

Select the maximum value that you want the rotor RPM to correlate to 100%.

HIGH ALARM:

This enables or disables the Rotor RPM high alarm.

HIGH ALARM:

Enter the Rotor RPM threshold for when the high alarm must be activated. Any Rotor RPM value above this value will activate the alarm.

HIGH CAUTION:

Enter the Rotor RPM value for the high caution. This is the lower value of the upper yellow band.

LOW CAUTION:

Enter the Rotor RPM value for the low caution. This is the upper value of the lower yellow band.

LOW ALARM:

This enables or disables the Rotor low alarm.

LOW ALARM:

Enter the Rotor RPM threshold for when the low alarm must be activated. Any Rotor RPM value below this value will activate the alarm.

PULSES/REV:

Enter the number of pulses per rotor RPM.

ROTOR RESOLUTION:

Select the step size between successive Rotor RPM values eg. if the Rotor RPM value is 403 RPM and the "*ROTOR RESOLUTION*" is 5 then the actual value shown is 405 RPM.

4.6.3 EGT/CHT Setup

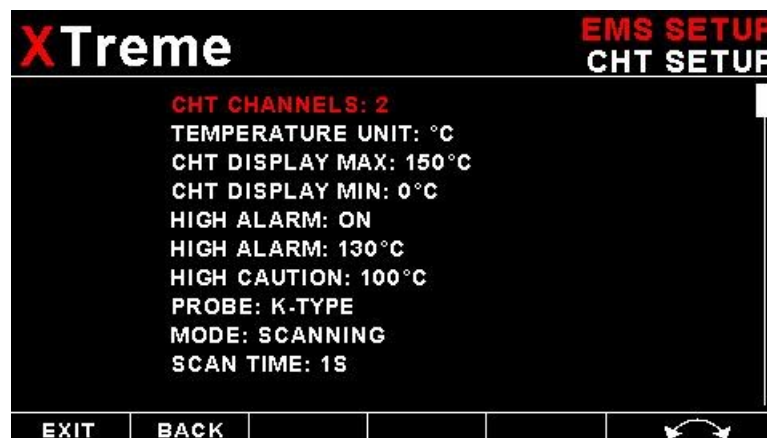
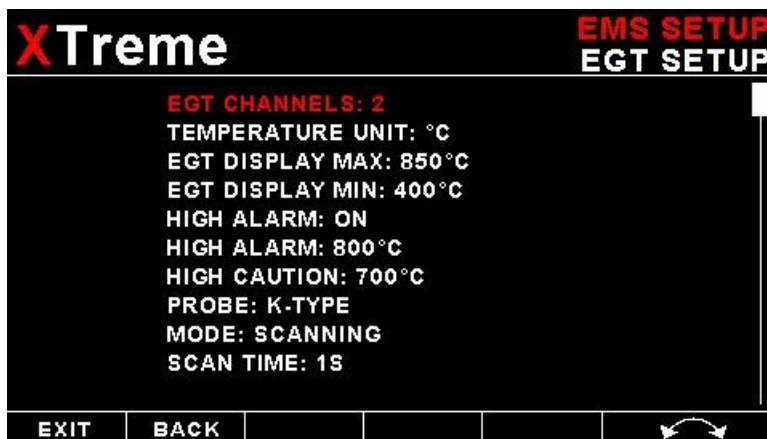

EGT/CHT CHANNELS:

Select the number of EGT or CHT channels you want to use. Choices are from 1 to 12. The temperature display will configure itself to make best possible use of the available display size. Please note that the minimum number of EGT & CHT channels that can be displayed is 1 and the maximum number of EGT and CHT channels that can be displayed is 12.

EGT/CHT DISPLAY MAX:

Select the maximum temperature that you want the EGT/CHT bargraph to show. This can give you increased display resolution.

EGT/CHT DISPLAY MIN:

Select the minimum temperature that you want the EGT/CHT bargraph to show. This can give you increased display resolution.

HIGH ALARM:

This enables or disables the EGT/CHT high alarm.

HIGH ALARM:

Enter the temperature threshold for when the high alarm must be activated. Any temperature above this value will activate the alarm.

HIGH CAUTION:

Enter the temperature value for the high caution.

PROBE:

Select if you are using a K-type, J-type or E-type thermocouple probe for the EGT/CHT group. All probes supplied by MGL Avionics are K-Type. J-types are sometimes used with American made CHT probes. All EGT probes are K-type. E-type probes are seldom used.

TEMPERATURE UNIT:

Select whether you want the EGT/CHT temperature to be displayed in degrees Celsius (°C) or degrees Fahrenheit (°F).

MODE:

A selection between "HIGHEST" or "SCANNING" can be selected. If "HIGHEST" is selected then the current highest thermocouple temperature is displayed. If "SCANNING" is selected then the unit will cycle through each thermocouple at the time specified in "SCAN TIME".

SCAN TIME:

Specify the time that each of the channels must be displayed for. This menu option is only shown if "SCANNING" is selected for the display mode.

4.6.3.1 Special Rotax 912/914 probe mode

In this mode the RDAC AUX 3 and AUX 4 analog input channels become the Rotax CHT channel 1 and CHT channel 2 respectively. All CHT setups must still be done under the "CHT SETUP" menu. The sender selection for the "AUX 3" and "AUX 4" must be set for "OFF". A probe type of "NTC" must be selected for the probe setting in the "CHT SETUP" menu.

The reason for using the NTC inputs is that the sensors Rotax use are standard NTC temperature probes and not of a thermocouple type.

4.6.4 Fuel Setup

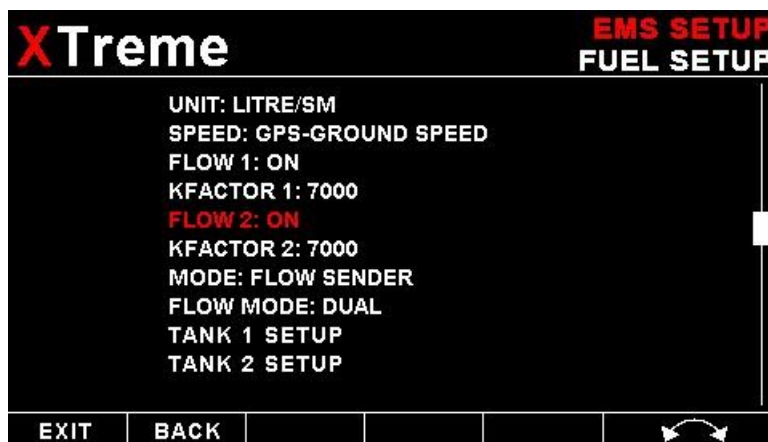

UNIT:

Select your desired units for distance and fuel quantity. The following options are available:

- L/sm: Liters and statute miles
- G/sm: U.S. Gallons and statute miles
- L/nm: Liters and nautical miles
- G/nm: U.S. Gallons and nautical miles
- L/km: Liters and kilometer
- G/km: U.S. Gallons and kilometers

SPEED:

Select which speed will be used for fuel range/endurance based calculations. You can select between "AIRSPEED-TAS" or "GPS-GROUND SPEED". If a 2D or 3D GPS is not obtained and "GPS-GROUND SPEED" is selected then the XTreme will default to use TAS for the fuel range/endurance calculations.

FLOW 1/2:

This enables or disables the Flow 1/2 display on the EFIS and MFD displays.

KFACTOR 1/2:

The K-Factor is the number of pulses generated by the fuel flow sender for one liter of fuel. The dual range fuel flow sender supplied by MGL Avionics has a K-Factor of 7000 in the low flow mode (jet installed) and 1330 for the high flow mode (no jet installed). The Flowscan 201A-6 has a K-Factor of 8454. You can use the K-Factor to calibrate your fuel flow sender. See the RDAC manual for more details on how to calibrate and install the fuel flow sender.

MODE:

Select if you want to measure fuel flow using a fuel flow sender or by using fuel injectors.

FLOW MODE:

If both fuel flow senders are selected then select if they are operating on individual fuel tanks (dual) or if they are operating in a supply/return type fuel system (differential).

TANK 1/2 SETUP:

Select this menu item to setup the fuel level for fuel tank 1/2. See below for more details.

Fuel level setup. (Only tank 1 setup is shown, follow the same steps for tank 2 setup)

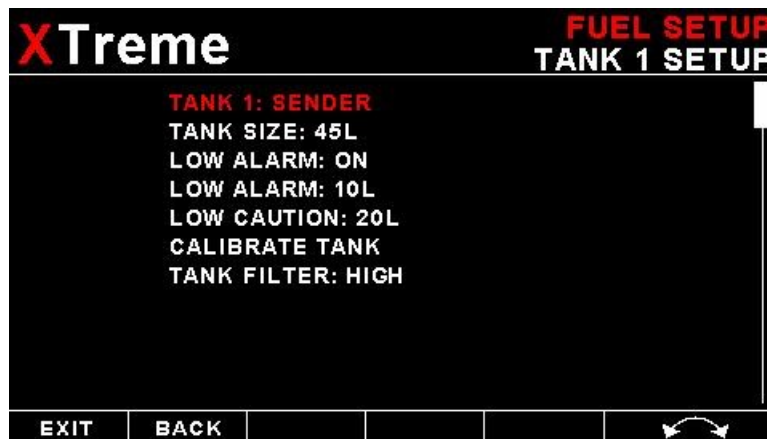

TANK 1/2:

Select if the fuel tank has a physical fuel level sender connected to it or if the Xtreme must use a calculation based virtual fuel tank. If you do not want any fuel level information then set this parameter to off.

TANK SIZE:

Enter the size of the fuel tank in your system. It is recommended to choose a size that is slightly less than the actual size so you can compensate for sender inaccuracies and give you a measure of reserve fuel.

LOW ALARM:

This enables or disables the fuel level low alarm.

LOW ALARM:

Enter your desired minimum fuel value that you would like to trigger the fuel low alarm.

LOW CAUTION:

Enter the fuel level value for the low fuel caution.

CALIBRATE TANK:

The fuel level sender needs to be calibrated before it can be used with this system. The calibration allows the system to learn the shape of your tank as well as any errors your fuel level sender or installation has.

Regardless of your use of a fuel flow sender, you can install a fuel level sender into your fuel tank. These level senders are inexpensive and are available as after market replacement fittings from a car spares outlet. We recommend the senders available from VDO.

Be aware that some makes of cheap level senders can prove troublesome, as the lever arms tend to be sticky. This prevents the floats from floating on the surface of the fuel at all times. As a consequence, this will lead to incorrect fuel level indication.

Adjusting calibration points automatically



Select “SENDER” for the “MODE” menu item. Once you have installed a fuel level sender into your tank, make sure the float can travel all the way from empty to full position without hindrance of any kind. The calibration procedure should be carried out with your aircraft in flight attitude. This means you need to lift the tail if you have a tail-dragger or lift the nose wheel if you have a weightshift trike.

Calibration procedure

- Start the calibration procedure with an empty tank.
- Add five liters of fuel (our reserve quantity) using a suitable measure. Make sure the measure is suitably accurate. This is now the “level sender reading at 0 Lt” position. Move the highlight to this position and wait until the sender reading has stabilized (You will see the sender reading at the top line). This could take up to a minute so have patience.

ENSURE THAT THE FLOAT IS NOT SUBMERGED AND IS FLOATING ON TOP OF THE FUEL LEVEL.

Should this number not react to changes of your level sender position, then you have a problem. Please check your wiring according to the installation section of this manual. You should expect the number to change in the region of at least 20 to 60 counts per calibration position. If the number does not change with fuel level or only changes a very small amount – check your installation. Something is not right!

- If you see the number changing then everything is well. Once it has stabilized and the highlight is on the 0 L position, press the rotary control to transfer the reading from the sender to the calibration point.
- Now you are ready for the next step. Add the required amount of fuel to get to the next level (In our case 9 Lt – this is 20% tank capacity). Once done, wait for the reading to stabilize and press the rotary control again after you have moved the highlight to the “9 L” position.
- Proceed in a similar manner until you have reached the last calibration position at 100% tank capacity.

You are done!

To finish your calibration, exit the calibration function by moving the highlight over the “- - -PREVIOUS MENU - - -” menu item and press the rotary control.

The instrument uses the 6 calibration points to work out a correction curve that takes into account the tolerances of your fuel level sender and the shape of your fuel tank. This results in an incredibly accurate and usable fuel level display that far exceeds that available from ordinary dial type gauges.

Adjusting calibration points manually

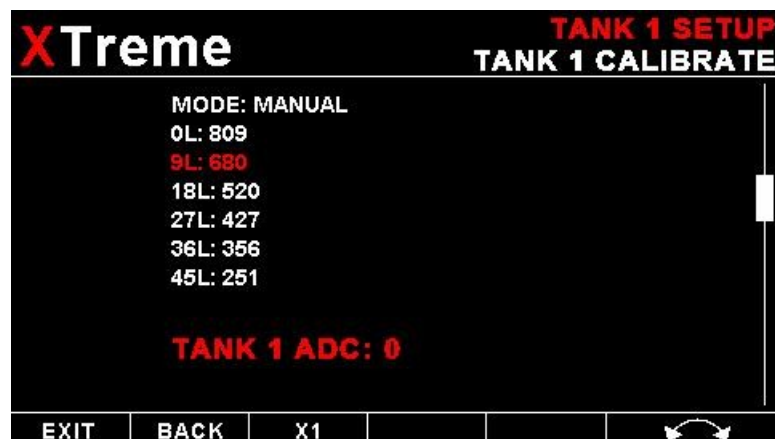

You may want to set individual calibration points manually. For example you may find that your fuel level is over reading at a specific fuel level. Correcting the tank level reading for this area can be simply done by adjusting the calibration point. You can do this by moving the float level with your hands to the desired position and then performing the calibration as outlined above, or you can use the manual option.

Select "MANUAL" for the "MODE" menu item. Then highlight the point you want to change manually and press the rotary control. Use the rotary control to adjust the value. Press the rotary control when done.

Note: The calibration positions may be edited by using the rotary control. This allows you, in theory, to copy calibration settings from one instrument to another. We however recommend that you do go through the calibration procedure even if the two aircraft are identical in all respects. Tolerances do exist and the calibration cancels these out. Accurate fuel level displays are a vital safety factor for an aircraft and a very useful feature for peace of mind during cross county flights.

Notes on Slope error

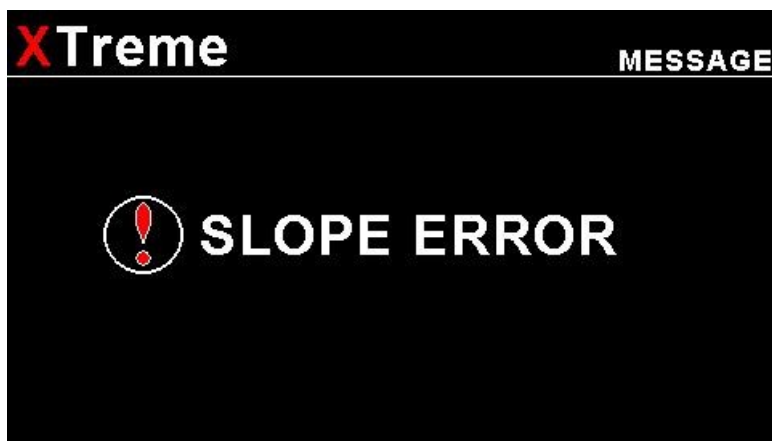

Sender value is a value determined by the XTreme. It is used to calculate fuel level, fuel endurance estimate and current range estimate. The fuel tank setup sender value can either increase in value as fuel is added or decrease in value if fuel is added. This is dependent on the type of fuel level sender used. However should the second reading be larger than the first reading all readings will have to be larger than the previous readings. Likewise should the second reading be smaller than the first reading all readings will have to be smaller than the previous reading.

If this is not the case the wording "SLOPE ERROR" will be displayed. This could happen when fuel was removed instead of added between steps, no fuel was added between steps or when the fuel level sender was moved in the wrong direction e.g. moving the fuel level sender manually when it is not inserted in to the fuel tank. Determine the cause of the error if you should get a slope error message. If you do not know the cause of your error it is best to start from scratch. It should be remembered that accuracy in the fuel tank calibration is extremely important to enable your XTreme to display the correct data.

TANK FILTER:

Select the damping factor for the fuel level. A selection of "NONE", "LOW", "MED" or "HIGH" can be made.

4.6.5 Manifold Setup

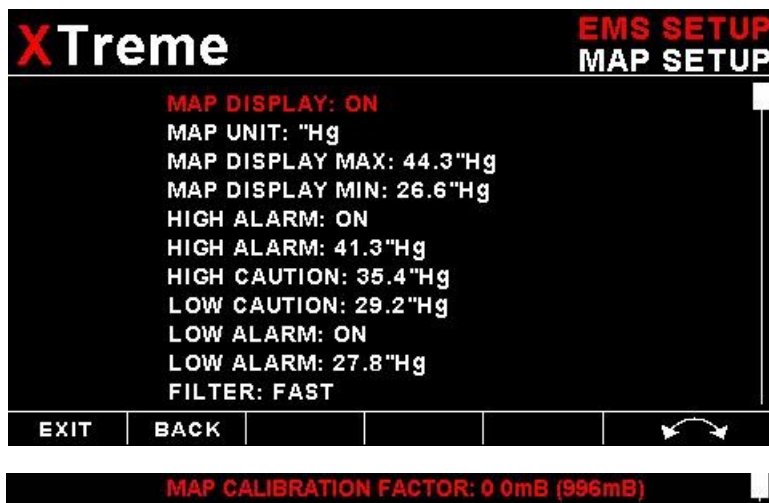

MAP DISPLAY:

This enables or disables the manifold pressure display on the EMS displays screens

MAP UNIT:

Select if you want the manifold pressure displayed in mB (millibars) or “Hg (inches of mercury).

MAP DISPLAY MAX:

Select the maximum pressure that you want the manifold bargraph in the EMS displays to show. This can give you increased display resolution.

MAP DISPLAY MIN:

Select the minimum pressure that you want the manifold bargraph in the EMS display to show. This can give you increased display resolution.

HIGH ALARM:

This enables or disables the manifold pressure high alarm.

HIGH ALARM:

Enter the pressure threshold for when the high alarm must be activated. Any pressure above this value will activate the alarm.

HIGH CAUTION:

Enter the pressure value for the high caution. This is the lower value of the upper yellow band.

LOW CAUTION:

Enter the pressure value for the low caution. This is the upper value of the lower yellow band.

LOW ALARM:

This enables or disables the manifold pressure low alarm.

LOW ALARM:

Enter the pressure threshold for when the low alarm must be activated. Any pressure below this value will activate the alarm.

FILTER:

This function can be used to select the signal filter time constant. Selections are “NONE”, “FAST” or “SLOW”. This selection influences the rate at which your manifold pressure can change its reading.

MAP CALIBRATION FACTOR:

The sender in the RDAC is shipped uncalibrated. To calibrate the manifold pressure, compare and adjust the calibration factor until the manifold reading is the same as the pressure value in brackets. The pressure value in brackets is the barometer reading built into the Xtreme. The manifold pressure can only be calibrated in mB.

4.6.6 Oil Temperature Setup

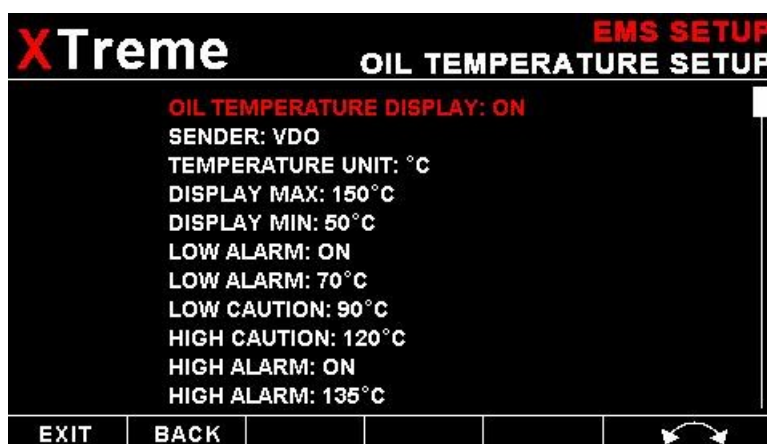

OIL TEMPERATURE DISPLAY:

This enables or disables the oil temperature display on the EMS displays screens

SENDER:

Select what type of sender you are using. Select “VDO” for a VDO resistive sender, “WESTACH” for Westach thermistor type senders, “MGL” for a MGL NTC resistive temperature sender, “LM335” for a MGL precision temperature sender or “USER” for a custom sender. The XTreme has a built in linearization curve for a standard 50°C to 150°C VDO resistive sender, Westach senders and the MGL NTC resistive sender.

If the sender type is set to “USER”

CALIBRATE SENDER:

If the sender type is set to “USER”, then use this menu option to calibrate your temperature sender. See section 4.4.9 for more information.

If the sender type is set to “LM335”

LM335:

If the sender type is set to LM335, then use this menu option to calibrate your LM335 precision temperature sender. If recalibration is required then adjust the value using the rotary control until the temperature matches the reference ambient temperature. Please note that the LM335 can only be calibrated in degrees Celsius irrespective if the XTreme is setup to display temperature in Fahrenheit.

Menu options for all sender types

TEMPERATURE UNIT:

Select whether you want the temperature to be displayed in degrees Celsius (°C) or in degrees Fahrenheit (°F).

DISPLAY MAX:

Select the maximum temperature that you want the oil temperature bargraph to show. This can give you increased display resolution.

DISPLAY MIN:

Select the minimum temperature that you want the oil temperature bargraph to show. This can give you increased display resolution.

LOW ALARM:

This enables or disables the oil temperature low alarm.

LOW ALARM:

Enter the temperature threshold for when the low alarm must be activated. Any temperature below this value will activate the alarm.

LOW CAUTION:

Enter the temperature value for the low caution. This is the upper value of the lower yellow band.

HIGH CAUTION:

Enter the temperature value for the high caution. This is the lower value of the upper yellow band.

HIGH ALARM:

This enables or disables the temperature high alarm.

HIGH ALARM:

Enter the temperature threshold for when the high alarm must be activated. Any temperature above this value will activate the alarm.

4.6.7 Oil Pressure Setup

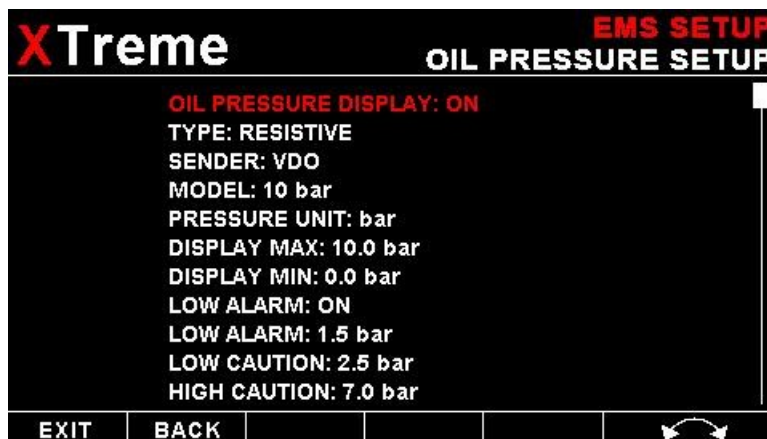

OIL PRESSURE DISPLAY:

This enables or disables the oil pressure display on the EMS displays screens

TYPE:

Select if you are using a resistive, 4-20mA or 0-5V output pressure sender.

If the “RESISTIVE” pressure sender is selected

SENDER:

Select what type of resistive pressure sender you are using. Select “VDO” for VDO / resistive senders, “USER” for a custom sender.

MODEL:

Select which VDO pressure sender you are using. A selection between a VDO 2, 5 or 10 Bar can be selected.

If the “0-5V” pressure sender is selected

SENDER:

Select the type of 0-5V sender used. Select “UMA” for UMA senders or “USER” for a custom 0-5V sender.

MODEL:

For UMA senders select the UMA model number.

If the “4-20mA” pressure sender is selected

SENDER:

Select the type of 4-20mA sender used. Select “ROTAX” for Rotax 912/914 4-20mA sender or “USER” for a custom 4-20mA sender.

PRESSURE @ 4mA:

Enter the pressure specified at 4mA output.

PRESSURE @ 20mA:

Enter the pressure specified at 20mA output.

If the “USER” pressure sender is selected**CALIBRATE SENDER:**

If the sender type is set to “USER”, then use this menu option to calibrate your pressure sender. See section 4.4.9 for more information.

Menu options for all sender types**PRESSURE UNIT:**

Select whether you want to display the pressure in Bar, PSI or PSI(0.1). The PSI(0.1) is for low range pressure senders e.g. UMA 7PSI.

DISPLAY MAX:

Select the maximum pressure that you want the oil pressure bargraph to show. This can give you increased display resolution.

DISPLAY MIN:

Select the minimum pressure that you want the oil pressure bargraph to . This can give you increased display resolution.

LOW ALARM:

This enables or disables the pressure low alarm.

LOW ALARM:

Enter the pressure threshold for when the low alarm must be activated. Any pressure below this value will activate the alarm.

LOW CAUTION:

Enter the pressure value for the low caution. This is the upper value of the lower yellow band.

HIGH CAUTION:

Enter the pressure value for the high caution. This is the lower value of the upper yellow band.

HIGH ALARM:

This enables or disables the manifold pressure high alarm.

HIGH ALARM:

Enter the pressure threshold for when the high alarm must be activated. Any pressure above this value will activate the alarm.

4.6.8 Auxiliary analog 3/4 Setup



The analog AUX3/4 channel on the RDAC is a general purpose channel that can be used for pressure as well as for temperature senders.

FUNCTION:

Select the function for the analog channel. Options are “PRESSURE”, “TEMPERATURE”, “CURRENT” or “OFF”.

If the “PRESSURE” function is selected:

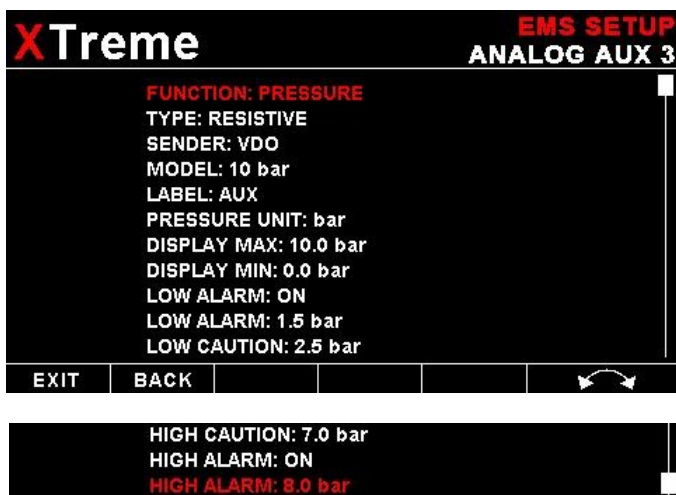

TYPE:

Select if you are using a resistive, 4-20mA or 0-5V output pressure sender.

If the “RESISTIVE” pressure sender is selected

SENDER:

Select what type of resistive pressure sender you are using. Select “VDO” for VDO / resistive senders, “USER” for a custom sender.

MODEL:

Select which VDO pressure sender you are using. A selection between a VDO 2, 5 or 10 Bar can be selected.

If the “0-5V” pressure sender is selected

SENDER:

Select the type of 0-5V sender used. Select “UMA” for UMA senders or “USER” for a custom 0-5V sender.

MODEL:

For UMA senders select the UMA model number.

If the “0-20mA” pressure sender is selected**SENDER:**

Select the type of 4-20mA sender used. Select “ROTAX” for Rotax 912/914 4-20mA sender or “USER” for a custom 4-20mA sender.

PRESSURE @ 4mA:

Enter the pressure specified at 4mA output.

PRESSURE @ 20mA:

Enter the pressure specified at 20mA output.

If the “USER” pressure sender is selected**SENDER:**

Select the type of 4-20mA sender used. Select “ROTAX” for Rotax 912/914 4-20mA sender or “USER” for a custom 4-20mA sender.

CALIBRATE SENDER:

If the sender type is set to “USER”, then use this menu option to calibrate your pressure sender. See section 4.4.9 for more information.

Menu options for all sender types**LABEL:**

Choose one of a selection of labels to suit your pressure input so you can identify it easily.

PRESSURE UNIT:

Select whether you want to display the pressure in Bar, PSI or PSI(0.1). The PSI(0.1) is for low range pressure senders e.g. UMA 7PSI.

DISPLAY MAX:

Select the maximum pressure that you want the bargraph to show. This can give you increased display resolution.

DISPLAY MIN:

Select the minimum pressure that you want the bargraph to show. This can give you increased display resolution.

LOW ALARM:

This enables or disables the pressure low alarm.

LOW ALARM:

Enter the pressure threshold for when the low alarm must be activated. Any pressure below this value will activate the alarm.

LOW CAUTION:

Enter the pressure value for the low caution. This is the upper value of the lower yellow band.

HIGH CAUTION:

Enter the pressure value for the high caution. This is the lower value of the upper yellow band.

HIGH ALARM:

This enables or disables the manifold pressure high alarm.

HIGH ALARM:

Enter the pressure threshold for when the high alarm must be activated. Any pressure above this value will activate the alarm.

If the “TEMPERATURE” function is selected:

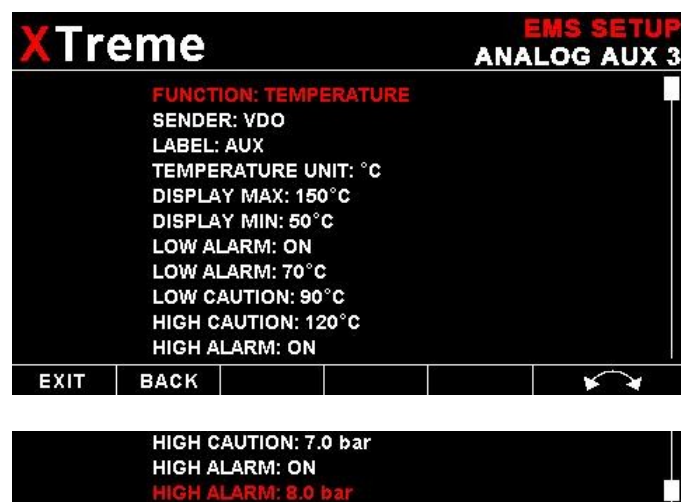

SENDER:

Select what type of sender you are using. Select “VDO” for a VDO resistive sender, “WESTACH” for Westach thermistor type senders, “MGL” for a MGL NTC resistive temperature sender, “LM335” for a MGL precision temperature sender or “USER” for a custom sender. The XTreme has a built in linearization curve for a standard 50°C to 150°C VDO resistive sender, Westach senders and the MGL NTC resistive sender.

If the sender type is set to “USER”

CALIBRATE SENDER:

If the sender type is set to “USER”, then use this menu option to calibrate your pressure sender. See section 4.4.9 for more information.

If the sender type is set to “LM335”

LM335:

If the sender type is set to LM335, then use this menu option to calibrate your LM335 precision temperature sender. If recalibration is required then adjust the value using the rotary control until the temperature matches the reference ambient temperature. Please note that the LM335 can only be calibrated in degrees Celsius irrespective if the XTreme is setup to display temperature in Fahrenheit.

Menu options for all sender types

LABEL:

Choose one of a selection of labels to suit your temperature input so you can identify it easily.

TEMPERATURE UNIT:

Select whether you want the temperature to be displayed in degrees Celcius (°C) or in degrees Fahrenheit (°F).

DISPLAY MAX:

Select the maximum temperature that you want the bargraph to show. This can give you increased display resolution.

DISPLAY MIN:

Select the minimum temperature that you want the bargraph to show. This can give you increased display resolution.

LOW ALARM:

This enables or disables the temperature low alarm.

LOW ALARM:

Enter the temperature threshold for when the low alarm must be activated. Any temperature below this value will activate the alarm.

LOW CAUTION:

Enter the temperature value for the low caution. This is the upper value of the lower yellow band.

HIGH CAUTION:

Enter the temperature value for the high caution. This is the lower value of the upper yellow band.

HIGH ALARM:

This enables or disables the temperature high alarm.

HIGH ALARM:

Enter the temperature threshold for when the high alarm must be activated. Any temperature above this value will activate the alarm.

4.6.9 Calibrating the user defined pressure and Temperature Senders

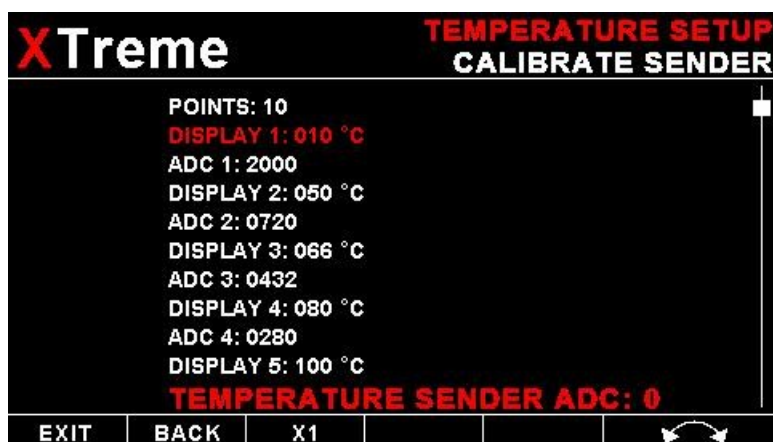

1. Enter the number of points that you want to calibrate.
2. Enter the display reading that you want to show when the sender is at that actual display reading.
3. Enter the ADC (analog to digital converter) reading that corresponds to this display reading. The ADC reading is shown at the bottom of the display if you are applying the actual stimulus from the temperature or pressure sender. You can also manually enter this value if the ADC value is known or pre-calculated.
4. Continue entering display and ADC values until all the points have been entered.
5. Verify the above calibration by checking the temperature/pressure display versus the actual applied sender stimulus.

If the “CURRENT” function is selected:

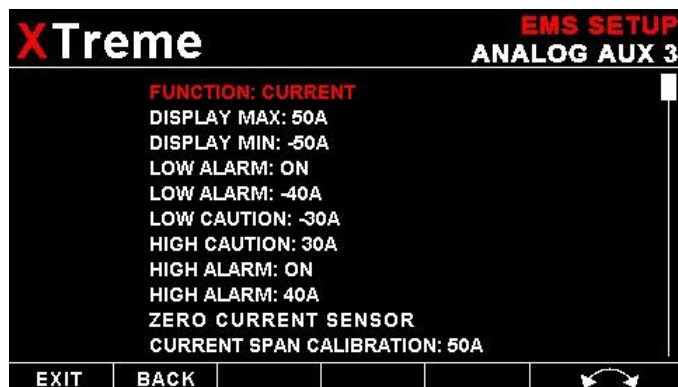

DISPLAY MAX:

Select the maximum current that you want the bargraph to show. This can give you increased display resolution.

DISPLAY MIN:

Select the minimum current that you want the bargraph to show. This can give you increased display resolution.

LOW ALARM:

This enables or disables the current low alarm.

LOW ALARM:

Enter the current threshold for when the low alarm must be activated. Any current below this value will activate the alarm.

LOW CAUTION:

Enter the current value for the low caution. This is the upper value of the lower yellow band.

HIGH CAUTION:

Enter the current value for the high caution. This is the lower value of the upper yellow band.

HIGH ALARM:

This enables or disables the current high alarm.

HIGH ALARM:

Enter the current threshold for when the high alarm must be activated. Any current above this value will activate the alarm.

ZERO CURRENT SENSOR:

Select this function to indicate to the XTreme that zero current is flowing through the MGL current monitor. This is best done with the MGL current monitor disconnected from the main current supplying conductor.

CURRENT SPAN CALIBRATION:

Enter the maximum value that your MGL current monitor can measure. This will depend on the distance and the method that is used to attach the MGL current monitor to the main current supplying conductor. It will be best if a multimeter can be inserted in series with the current supplying conductor and the span calibration adjusted until the XTreme matches that of the multimeter. Please see the MGL current monitor document for more information.

4.7 Compass Setup

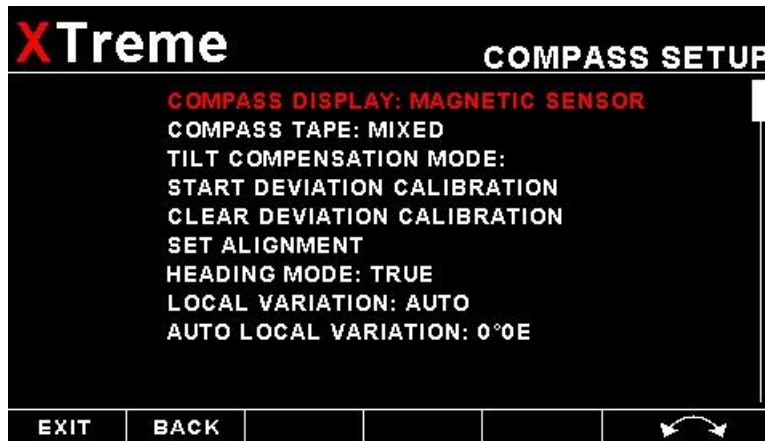

COMPASS DISPLAY:

Select "MAGNETIC SENSOR" if you have a MGL Avionics SP2 or SP6 compass sensor attached to the Xtreme. Select "GPS TRACK" if you want the compass displays to indicate GPS track (The compass display color will change to the color Magenta.)

COMPASS TAPE:

Select the desired compass display mode. A selection from "MIXED", "CARDINAL" or "NUMERIC" can be selected.



"MIXED" shows headings as number in degrees except for the four major cardinal points which are shown as N,S, E and W.



"CARDINAL" shows headings as major and minor cardinal points: N, NNE, ENE, E, ESE, SSE, S, SSW, WSW, W, WNW, and NNW.



"NUMERIC" shows headings as numbers in degrees.

TILT COMPENSATION MODE:

Select the mode you would like your compass to operate under:

2D: This mode selects a two axis compass system. This has no tilt compensation.

3D A: This mode selects a three axis compass system. Tilt compensation by means of gravity vectoring via accelerometers.

3D G: This mode selects a three axis compass system. Tilt compensation by means of information supplied by an artificial horizon (MGL Avionics SP4/SP5).

Mode	Advantages	Disadvantages
2D	Most accurate as long as the compass remains level. Not affected by turns or acceleration provided compass remains level during turns.	Large heading errors when compass is tilted. The magnitude of these errors is dependent on the heading, type of tilt (pitch and/or bank) as well as location on Earth.
3D-A	Self-contained tilt compensated compass. Will compensate for most tilt errors up to 60 degrees of tilt.	Cannot correctly compensate for tilt during any form of turn due to centrifugal forces acting on the accelerometers.
3D-G	Can provide for accurate heading even during turns as tilt compensation is based on gyro derived horizon.	Can show very large errors if the horizon information is invalid which could have a

	number of causes such as exceeding operational limitations of the horizon system.
--	---

START DEVIATION CALIBRATION:

When you install your compass sensor package, it may be surrounded by several items or materials that in some way change the strength and/or direction of the earth magnetic field that your sensors are measuring. If left unattended, this may contribute to considerable errors in the heading as indicated by your instrument.

Due to the magnetic sensor not being based on a magnetic item (such as a magnetic needle) as in a normal compass, the effect of deviation is lessened a little. This is because the needle in a magnetic compass will be attracted by iron, even if the offending iron has no effect on the magnetic field (i.e. does not change the field direction or strength in a hypothetical case).

Deviation needs to be corrected if you intend using the compass for navigational purposes. The procedure for this is traditionally called a “compass swing”. Often, two small magnets are placed close to the compass in an effort to correct some of the larger errors. Smaller, remaining errors are then noted on a “deviation chart” and this is placed next to the compass for future reference.

With the SP-2, a very simple method can be used to correct for most of the deviation that may be present in your aircraft or vehicle. However, before you start, ensure that the sensor package is installed as far away as possible from any of the following:

- Ferro magnetic materials such as iron, many steels and soft magnetic materials such as ferrites. Any magnets must be located as far away as possible from the sensor package. This includes electromagnets as used in solenoids, electrical motors and relays.
- Cables containing large electrical currents. DC currents will cause magnetic fields around the cables which will lead to deviation. AC currents cause fluctuating magnetic fields that may reduce your compass resolution.
- Be aware that some lower grades of stainless steel may be ferro magnetic.

If in any doubt, use a small magnet to test any metals surrounding the sensor package. We recommend mounting the sensor package using glued on strips of velcro material. This allows for easy alignment of the sensor package horizontal to the earth’s magnetic field.

Never perform the deviation compensation procedure or a compass swing if your aircraft is placed on a reinforced concrete apron or tarmac. The steel that may have been used to reinforce may have a very significant effect on the strength and direction of the magnetic field at your location.



Place your aircraft in flight attitude. For example, if you own a tail-dragger, raise the tail. Some tricycle gear aircraft may need to raise the nose gear slightly. The object is to place the sensor package as close to horizontal attitude relative to the earth’s surface as you possible.

Proceed as instructed and turn the aircraft through a full 360 degrees at least once. Allow this procedure to take some time, perhaps a minute. You can proceed to turn your aircraft though two or more turns, however you need to fully complete at least one full turn.

Once you have completed your turn(s), select “DONE” to inform the instrument that you have finished. Your instrument will at this point calculate the best possible fit of the sensor data to a 360 degree arc taking the relative strengths and offsets of the magnetic field into account. This procedure can result in remarkably good overall performance of your compass.

Please note: After this procedure has been completed, you may have to verify the compass performance by performing a normal compass swing. Should any deviation remain, you need to note this on a deviation card and place this card next to the compass. This may be a legally required procedure in your country for your aircraft class. Please check your relevant regulations. Deviation compensation and compass swing may need to be repeated from time to time as the magnetic properties of metals in your aircraft may change over time.

CLEAR DEVIATION CALIBRATION:

Clears any previous deviation compensation and returns the instrument to factory calibration.

SET ALIGNMENT:



The purpose of this function is to cancel out the remaining errors on the main cardinal headings after a deviation compensation calibration has been done.

Align your aircraft exactly on a North/South heading, pointing North. Use another compass outside of the aircraft to ensure that you are aligned exactly on the North/South axis. Select the "SET NORTH" function.

Repeat the above calibration for the South, East and West cardinal headings.

This function, if used properly can lessen any remaining deviation that may be present after you have performed the prescribed compass swing. If you cannot find a successful setting using both methods, examine your installation location more closely. Perhaps you have an interfering metal part nearby. You may need to choose a different location to mount the compass sensor.

Note: *In difficult circumstances it may not be possible to find a location for the sensor inside the fuselage of your aircraft. This may be particularly true for aircraft based on tubular steel frames. In this case you need to locate the compass sensor inside the wing (perhaps in a wing-tip).*

HEADING MODE:

Select if you want all heading related data to indicate true or magnetic north.

LOCAL VARIATION:

Select "AUTO" to allow the XTreme to automatically calculate the local variation or "MANUAL" for manual local variation input.

AUTO LOCAL VARIATION:

This item displays the calculated local magnetic variation. The XTreme will calculate the local variation every 10 minutes if a valid 2D or 3D GPS fix is obtained.

MANUAL LOCAL VARIATION:

This item allows the pilot to manually enter his local variation.

Please note: The XTreme will only use the automatically calculated variation if a valid 2D or 3D GPS fix is obtained otherwise it will use the manual local variation value. It is recommended to enter the local magnetic variation in case of GPS loss..

4.8 Horizon Setup

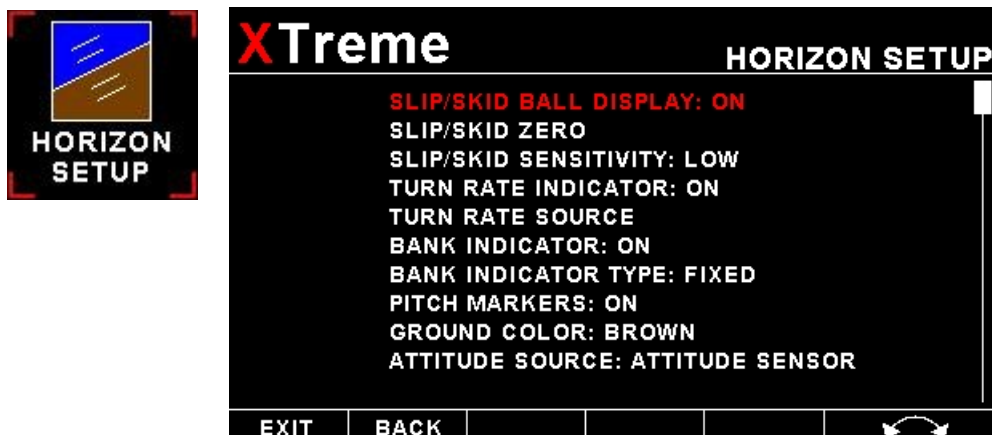

SLIP/SKID BALL DISPLAY:

Select if you would like to enable the slip indicator to be shown underneath the horizon display. The slip indicator operates in the same fashion as the well known “step on the ball” indicator in traditional cockpits.

SLIP/SKID ZERO:

This function allows you to set your slip indicator to exactly zero even if your aircraft tends to fly slightly wing down. The procedure is to place the aircraft in a stable, straight and level attitude during calm flight conditions and then select this function. To cancel the correction, place your sensor absolutely horizontal (use a spirit level) and select the function again.

SLIP/SKID SENSITIVITY:

Select if you want the slip/skid ball to have a high sensitivity or a low sensitivity setting

TURN RATE INDICATOR:

This enables or disables the turn rate indicator on the EFIS and MFD displays.

TURN RATE SOURCE:

Select whether you want the turn and bank indicator’s information source to be the bank angle or actual turning information from the gyros (SP-X dependant).

BANK INDICATOR:

This enables or disables the bank indicator markings on the EFIS and MFD displays.

BANK INDICATOR TYPE:

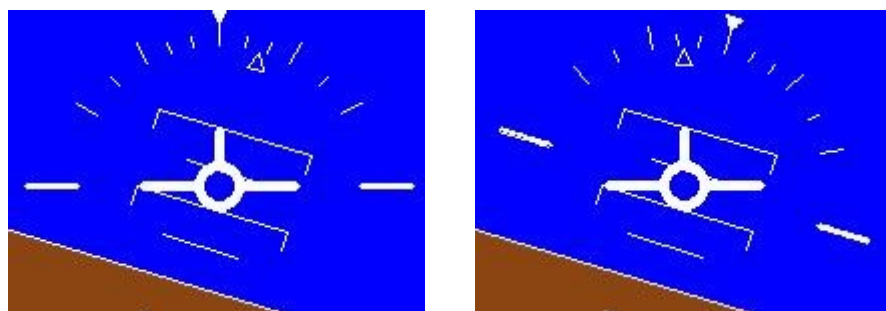

Select whether the bank indicator markings are “MOVING” or are “FIXED” (default) The “FIXED” bank indicator has an clear arrow which moves to stay perpendicular with the horizon, the “MOVING” bank indicator rotates the scale around a stationary arrow.

PITCH MARKERS:

This enables or disables the pitch markers on the EFIS and MFD displays.

GROUND COLOR:

Select the color of the ground in the EFIS display. A selection between "BROWN" (default) or "GREEN" can be made.

ATTITUDE SOURCE:

Select the source of the attitude indication for the EFIS display. Select "ATTITUDE SENSOR" for a MGL Avionics attitude sensor package, "GPS FLIGHT PATH" for a gps based attitude indication or "NONE" for a grey background EFIS display.

If the attitude source is set to "GPS FLIGHT PATH" the following must be considered:



The GPS Flight path feature uses a method to calculate bank and pitch angles from information obtained from the internal GPS receiver. This is no means a replacement for a real gyro based AHRS unit but is more intended as a informative / simulated display of the horizon.

This feature is only available using the internal GPS receiver due to the high update rates required by the internal calculations. The GPS Flight Path requires a 2D or 3D GPS fix. If a 2D GPS fix is obtained then the pitch angle uses the VSI instead of the vertical vector in determining the pitch angle. The GPS Flight Path is engaged only when the airspeed is greater then 20mph.

The GPS Flight Path can be used as a low cost artificial horizon display allowing the pilot to be able to have the look and feel of a real EFIS display without the additional cost of a AHRS sensor unit.

The text "GPS FLIGHT PATH NO ATTITUDE" is displayed when the GPS Flight Path is enabled. This cannot be removed from the display and reminds the pilot of the limitations thereof.

The GPS Flight Path is based on coordinated flight and it will display incorrect horizon information during unusual uncoordinated flight maneuvers.

WARNING

This is no means a replacement for a real gyro based AHRS unit but is more intended as a informative / simulated display of the horizon. This is strictly not to be used for IMC/IFR flights. MGL Avionics or any of its distributors take no responsibility for the use of the GPS Flight Path feature and it is the sole responsibility of the pilot in command to familiarize themselves with the use and limitations of using such a technology.

4.9 GPS Setup

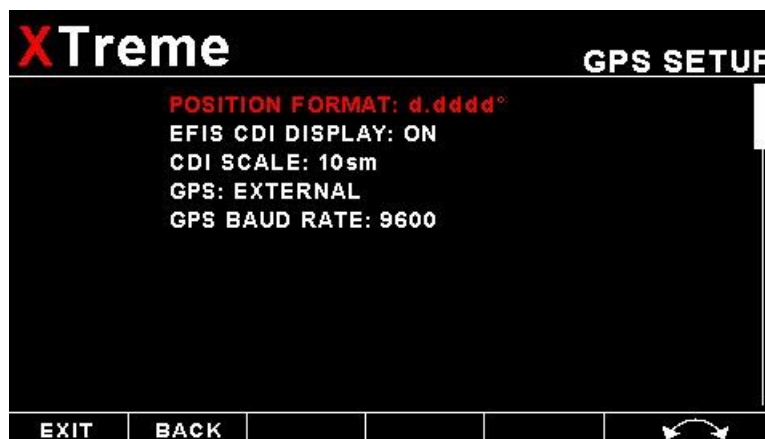

POSITION FORMAT:

Select the display format of the GPS latitude and longitude.

EFIS CDI DISPLAY:

Select "ON" to enable the EFIS CDI display at the bottom of the EFIS displays.

CDI SCALE:

Use this function to adjust the CDI scale to either 1, 2, 5 or 10.

GPS:

Select "INTERNAL" if you want to use the internal GPS (default) or "EXTERNAL" if using an external GPS receiver.

If an external GPS is used then it must output the following NMEA sentences

- GGA - Global positioning system fix data
- RMC – Recommended minimum specific GNSS data
- GSA – GNSS DOP and active satellites
- GSV – GNSS satellites in view

NMEA stands for the National Marine Electronics Association. For more information please visit www.nmea.org.

Note: The GPS flight path will only work if the internal GPS receiver is used.

GPS BAUD RATE:

The baud rate defaults to "9600" baud if using the internal GPS otherwise set the baud rate to match the external GPS receiver you are using.

4.10 Timers Setup



HOBBS MINIMUM RPM:

Enter the RPM limit in which the Hobbs timer/Maintenance timer must start incrementing.

SET HOBBS TIME:

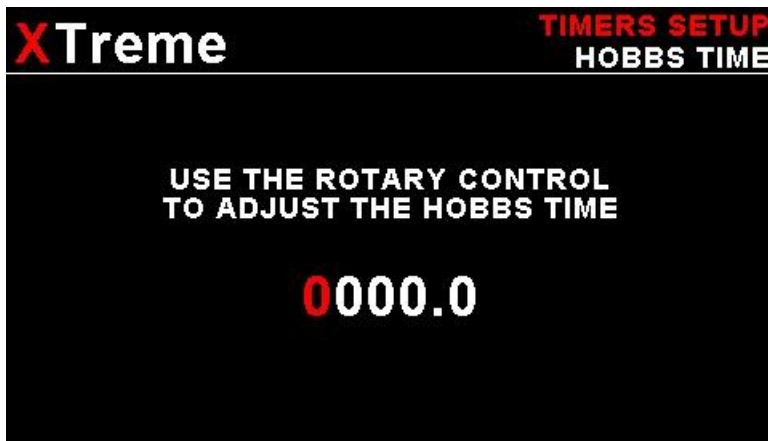

This function allows you to set the engine Hobbs meter to any value. Typically, you would use this function to set the Hobbs meter to the current known engine time. Use the rotary control to change the value. Press the rotary control to accept and exit the menu option. If the Hobbs code is set to another value beside zero, then the pilot will be prompted to enter the Hobbs access code before allowing him to change the Hobbs time. This feature is useful for chartered and flying school planes.

CHANGE HOBBS CODE:

This menu option allows you to change the Hobbs access code. You will first be prompted to enter the current code followed by entering in a new code followed by re-entering the new code. If the new code and the re-entered code is the same, then the Hobbs access code will be changed. Default code is 0000.

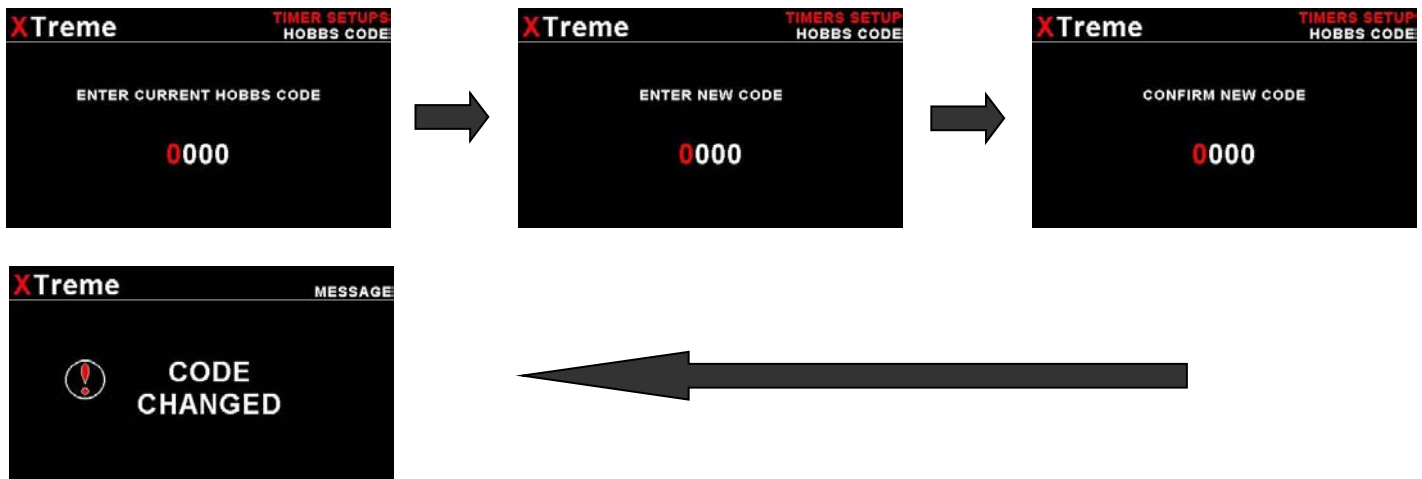

SET MAINTENANCE TIMER:

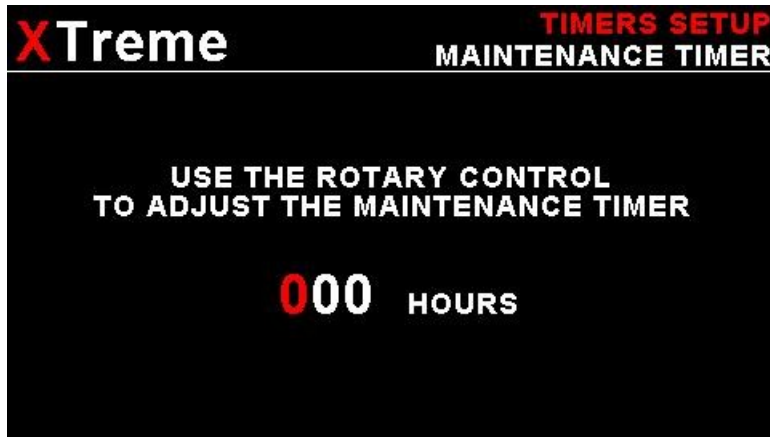

These timers allow you to keep track of engine maintenance interval. Set the timer when you have serviced your engine. A typical time might be 50 hours. This function allows you to set an engine maintenance timer. This timer is set in engine hours and it will count down to zero when the engine RPM is greater than the "HOBBS MINIMUM RPM". A good use for this function is to set the hours until your next spark plug change or engine inspection. Use the rotary control to change the value.

SET AIRFRAME INSPECTION TIMER:

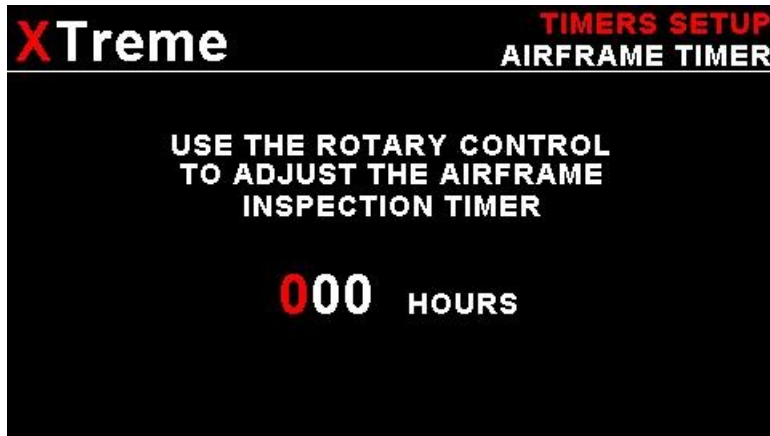

This timer operates similar to the engine maintenance timer but is based on flight time. You might use it to schedule thorough airframe checks at intervals, perhaps every 25 or 50 hours.

UTC OFFSET:

Enter the UTC offset for your location. The UTC offset can be adjust in half an hour increments.

RTC SOURCE:

Select if you want the RTC UTC time to come from the GPS receiver or the internal RTC. Both real time clocks are powered by an internal 3V lithium coin cell battery. The internal battery can be replaced by unscrewing the 5 screws holding the back and front enclosures together as well as the 2 screws next to the D15 connector. Delicately slide out the electronics and replace the battery. The battery is a CR2032 coin cell.

SET UTC DATE & TIME:



Use the rotary control to set the UTC date & time in the internal RTC.

4.11 Electrical System Setup

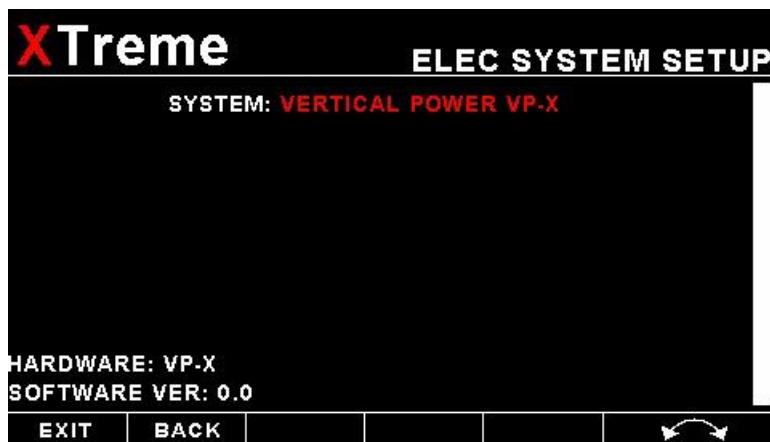

The electrical system setup menu option allows the pilot to select what electrical system/ECB (Electronic Circuit Breaker) is attached to the XTreme EFIS. The XTreme supports the Vertical Power VP-X range of electrical systems/ECBs.

Please note that the XTreme has only 1x RS232 serial port that can only have one piece of equipment connected to it. Equipment includes: serial altitude encoder, Electrical system (Vertical Power VP-X) and the CO Guardian carbon monoxide detector.

SYSTEM:

Select "VERTICAL POWER VP-X" to display the electrical system screen.



4.12 CO Guardian Carbon Monoxide Setup

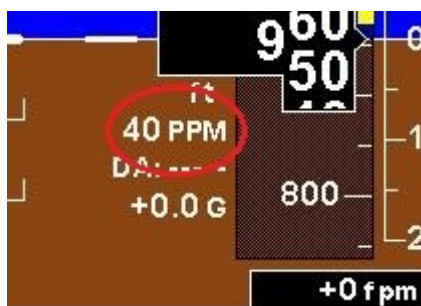

The CO Guardian Carbon Monoxide menu option allows the pilot to enable the CO Guardians Carbon Monoxide detector. The XTreme will display the carbon monoxide value on the EFIS display as well as enable the carbon monoxide warning alarm. Please see the relevant CO Guardian detector manuals for more information.

Please note that the XTreme has only 1x RS232 serial port that can only have one piece of equipment connected to it. Equipment includes: serial altitude encoder, Electrical system (Vertical Power VP-X) and the CO Guardian carbon monoxide detector.

CO GUARDIAN:

Selecting “ON” will enable the carbon monoxide value on the EFIS displays.

RESET CO GUARDIAN:

This will reset the CO Guardian Carbon Monoxide detector, perform a self test and then will re-enable the CO Guardian Carbon Monoxide detector.

4.13 Data Recording Setup

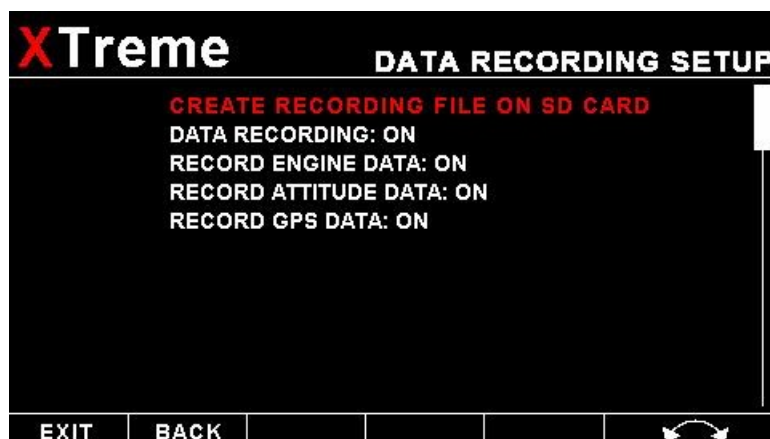

The XTreme has the ability to act as a black box recorder recording flight data directly onto an inserted SD card for later playback and investigation using the MGL Avionics Enigma Black Box viewer program. See the Enigma Black box viewer documents for further information. The Black box viewer can also convert the data into other file formats such as:

- KML: Keyhole Markup Language / Google Earth
- CSV: Comma-Separated Variable
- IGC: FAI Gliding commission

The XTreme automatically records the following flight data when the data recording is enabled:

- Data and Time
- Altitude
- Barometer
- Airspeed
- TAS
- VSI
- Glide/climb ratio
- Volts
- OAT

Other fields such as engine data, attitude, and GPS data are user selectable. The XTreme records all available data for each selected category once per second WHEN A VALID FLIGHT IS DETECTED (AUTOMATIC OR MANUAL FLIGHT DETECT MODE).

CREATE RECORDING FILE ON SD CARD:

Selecting this menu option will create a file on the SD card (If inserted and not write protected) called enigma.rec with a fixed file size of 10MB. The reason behind the fixed file size of the recording file has to do with limited write cycles of the SD card and the instability of the MS-DOS file system. With a fixed file size, the EFIS never has to write to either the directory structure or FAT tables of the SD card eliminating wear of the card or possible data corruption. Once the recording file has been filled, the recording continues at the start of the file again, overwriting the oldest data in the file.

The file size is large enough to record 5-20 hours of data depending on what data is recorded.

DATA RECORDING ON:

Selecting "ON" will enable the data recording functionality.

RECORD ENGINE DATA:

Select "ON" to include the engine data in the recorded flight data.

RECORD ATTITUDE DATA:

Select "ON" to include the attitude data in the recorded flight data.

RECORD GPS DATA:

Select "ON" to include the GPS data in the recoded flight data.

4.13.1 Examples of the exported flight data using CSV format and the KML format

EnigmaCSV - OpenOffice.org Calc

File Edit View Insert Format Tools Data Window Help

Arial 10 B / U

I25 f(x) Σ =

	A	B	C	D	E	F	G	H	I	J	K	L	M	N	O	
1	Date Time	Alt	Baro	ASI	TAS	VSI	Glide S	RRPM	main V	bckp V	Amps	AOA	OAT	ERPM	RFL1	RF
2	PFD	PFD	PFD	PFD	PFD	PFD	PFD	PFD	PFD	PFD	PFD	PFD	PFD	PFD	RDAC 1	RDAC 1
3	MM/dd/yy hh:mm:ss	feet	mB	m/h	m/h	ft/m	none	RPM	V	V	A	none	degC	RPM	none	no
4	01/01/2000 00:49:20	-75	3356	31	31	22	99.9	32768	11.3	10.8	0	0	14	4440	2043	
5	01/01/2000 00:49:22	-73	3356	34	34	0	0	32768	11.4	10.9	0	0	14	4402	2043	
6	01/01/2000 00:49:24	-73	3357	37	37	-11	-99.9	32768	11.4	10.9	0	0	14	4167	2043	
7	01/01/2000 00:49:26	-74	3356	40	40	-22	-99.9	32768	11.4	10.9	0	0	14	4317	2043	
8	01/01/2000 00:49:28	-71	3355	42	42	-11	-99.9	32768	11.2	10.7	0	0	14	4341	2043	
9	01/01/2000 00:49:30	-70	3356	44	44	0	0	32768	11.3	10.8	0	0	14	4504	2043	
10	01/01/2000 00:49:32	-68	3356	46	46	11	99.9	32768	11.3	10.9	0	0	14	4504	2043	
11	01/01/2000 00:49:34	-66	3355	47	47	0	0	32768	11.4	10.9	0	0	14	4427	2043	
12	01/01/2000 00:49:36	-67	3355	48	48	-11	-99.9	32768	11.3	10.8	0	0	14	4504	2043	
13	01/01/2000 00:49:38	-67	3355	50	50	-11	-99.9	32768	11.3	10.8	0	0	14	4491	2043	
14	01/01/2000 00:49:40	-66	3356	51	51	-11	-99.9	32768	11.4	10.9	0	0	14	4491	2043	
15	01/01/2000 00:49:48	-71	3356	43	43	22	99.9	32768	11.4	10.9	0	0	14	4112	2043	
16	01/01/2000 00:49:50	-70	3356	43	43	45	84	32768	11.4	10.9	0	0	14	4201	2043	
17	01/01/2000 00:49:52	-70	3355	44	44	22	99.9	32768	11.4	10.9	0	0	14	4212	2043	
18																
19																

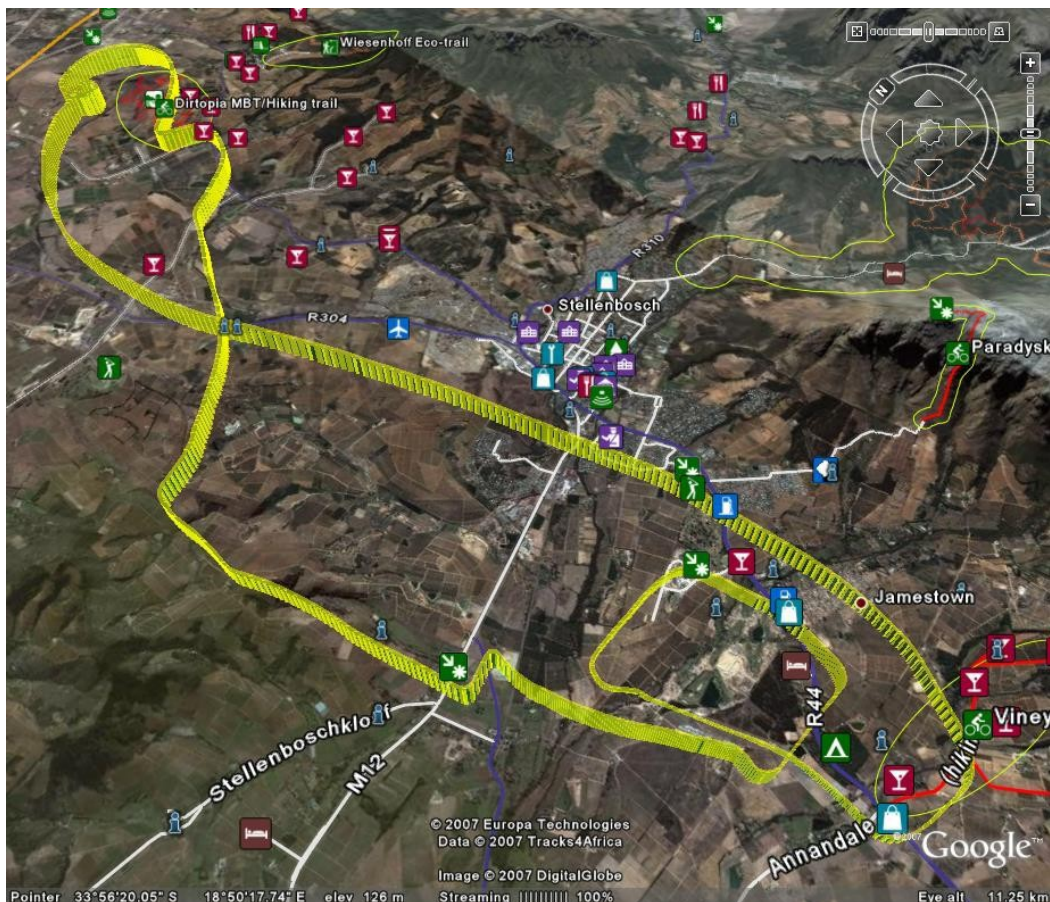

4.14 Display Setup



The display setup menu option allows the pilot to select if certain display screens must be shown or not when toggling through the displays using the left or right most soft keys.

EFIS DISPLAY:

Select "ON" to display the full screen EFIS screen.

EFIS/EMS DISPLAY:

Select "ON" to display the 2/3 screen EFIS screen and 1/3 engine monitoring screen.

EFIS/HSI DISPLAY:

Select "ON" to display the 2/3 screen EFIS screen and 1/3 HSI screen.

VFR DISPLAY:

Select "ON" to display the full screen VFR screen.

VFR/EMS DISPLAY:

Select "ON" to display the 2/3 screen VFR screen and 1/3 engine monitoring screen.

EMS DISPLAY:

Select "ON" to display the full screen engine monitoring screen.

GPS DISPLAY:

Select "ON" to display the GPS information screen.

INFO/CHECKLIST DISPLAY:

Select "ON" to display the Information/Checklist screen.

4.15 Miscellaneous Setup



WIND SPEED/DIRECTION:

Select if you want the wind speed / direction displayed on the EFIS and MFD display screens.

The following variables must be available in order to calculate the wind speed/wind direction

- A valid 2D or 3D GPS fix
- Magnetic heading (Requires MGL Avionics SP2/SP6 magnetic compass)
- TAS

G-FORCE:

This enables or disables the G-Force display on the EFIS type display screens.

AIRCRAFT REGISTRATION:



Enter your aircraft registration. A maximum of 8 characters can be entered. The aircraft registration is displayed on the start up (Splash) screen.

SAVE SETTINGS TO SD CARD:

Select this option to save all the XTreme settings to the SD card. This is useful when setting up the instrument on the PC simulator and then later transferring the settings on the instrument itself. A file called "SETTINGS.XT" will be created in the root directory of the SD card.

RECALL SETTINGS FROM SD CARD:

Select this option to recall all the XTreme settings from the SD card. This is useful when setting up the instrument on the PC simulator and then later transferring the settings to the instrument itself. The settings will be loaded from a file called "SETTINGS.XT" in the root directory of the SD card.

4.16 ADC Values

These values are mainly used for debugging purposes. Contact the MGL factory or your local dealer for more information.

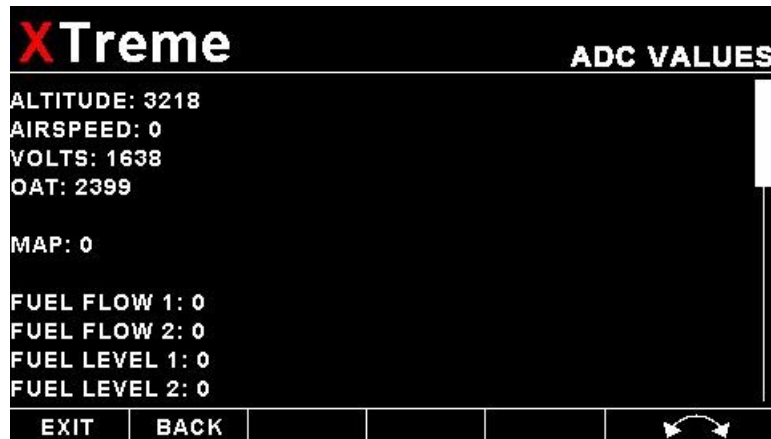

5 Startup (Splash) Screen

Creating your own Startup (Splash) Screen

You will need:

- A bitmap picture of your choice (*.BMP, 480x272 pixel resolution)
- The Enigma BMP to MIF converter tool (can be downloaded free of charge from <http://www.mglavionics.co.za> or can be found on the XTreme SD card).

The Enigma BMP to MIF program is used to convert images in Windows BMP format to Enigma MIF format. You can use this program to make your own startup screen (Splash screen) and graphic information display screens. The color depth is limited to Enigma's 256 colors.

Run the Enigma BMP image to MIF format converter program.

Load an image file (and remember the location), select the resolution as width(480) and height (272) and press the process button. The new MIF image will be located in the same directory as the source (BMP) file. If the original file was not named Splash.BMP, rename the new *.MIF file to Splash.MIF, and copy the Splash.MIF file into the root directory of your SD card.

The picture will be displayed when the unit is powered up.

6 Loading factory default settings

Press and hold the left and right most soft keys simultaneously on power up to load default factory settings. The following screen will be displayed:

**LOADING DEFAULT
SETTINGS**

7 Alarm condition

**ALARM
RPM HIGH**

879

If an alarm condition occurs the following will happen:

- The item causing the alarm condition will flash on the screen
- An alarm warning message will be displayed on the screen
- An external alarm switch will close

The alarm warning message and switch closure will remain until any button is pressed or until the condition(s) that activated the alarm no longer exist.

The alarm output can be used to switch an external alarm indicator. The external alarm switch is an open collector transistor switch to ground with a maximum rating of 0.5A DC. It is possible to wire the alarm contacts of several Stratomaster instruments in parallel should this be desired.

To avoid false activation of the alarms, the alarm function is only active 10 seconds after the instrument has powered up.

8 Cleaning

The unit should not be cleaned with any abrasive substances. The screen is very sensitive to certain cleaning materials and should only be cleaned using a clean, damp cloth.

Warning: The XTreme is not waterproof. Serious damage could occur if the unit is exposed to water and/or spray jets.

9 XTreme Specifications

Operating Temperature Range	-10°C to 50°C (14°F to 122°F)
Storage Temperature Range	-20°C to 80°C (-4°F to 176°F)
Humidity	<95% RH non-condensing
Power Supply	8 to 30Vdc SMPS (switch mode power supply) with built in 33V over voltage and reverse voltage protection
Current Consumption	Approx. 200mA @ 13.8V
Display	4.3" 480x272 pixel, 600 nits active matrix TFT LCD (Sunlight Readable). LED backlight is user adjustable.
Dimensions	see section 12 for dimensional drawings
ADC	16bit 100ksps
Enclosure	3 1/8" ABS, black in color, front mounting. See XTreme dimensional drawing
Weight	Approx. 530 grams (includes Xtreme, cable, GPS antenna & OAT sensor)
Alarm contact current rating	Open collector transistor switch to ground. Maximum rating 0.5A DC
Non-volatile memory storage	100000 write cycles
Warm up time	10 minutes
Altimeter	
Altimeter range	-700ft to 30 000ft (-213m to 9144m)
Altimeter resolution	1ft/1m
Altitude measurement accuracy	+/- 1mB, +/- 30ft at sea level
Connection	1/8" NPT female fitting
Airspeed	
Airspeed range	16mph to 250mph
Airspeed resolution	1 mph
Measurement accuracy	+/-1% at 85mph nominal
Connection	1/8" NPT female fitting
VSI	
Digital VSI scale	1000ft/min, 2000ft/min and 4000ft/min / 5m/s,10m/s and 20m/s
Digital VSI resolution	1ft/min / 0.1m/s
Voltage	
Range	8 to 30V DC
Resolution	0.1V
GPS	
Channels	50
Correlators	>1 000 000
Update rate	4 Hz
Time to First Fix (TTFF)	<1 Second
Antenna	External active antenna
Antenna connection	SMA

10 Installation

10.1 Altimeter Installation

Connect the static port to a suitable static air pressure line. If you have a slow aircraft or an aircraft where the internal cabin pressure does not change during flight and is equivalent to the outside air pressure you may find that it is not required to connect a static port.

For installations in typical ultralight aircraft pods, be aware of possible pressure changes inside the pod during flight caused by ram air or suction effects. This may lead to a false indication of altitude and airspeed. Often these effects are dependent on the current angle of attack of the airflow around your pod. You will need to install a suitable static port in these cases.

Static ports are usually mounted at a strategic position on the rear side of the aircraft fuselage for faster, pressurized aircraft. The Static port is terminated in a female 1/8" NPT fitting, you will be required to use a standard 1/8" NPT male fitting.

10.2 Airspeed Installation

Connect your pitot tube to the "PITOT TUBE" port. Pitot tubes are found in a large variety at your aircraft parts shop, in mail order catalogs or you can make your own. Contrary to popular belief, pitot tubes are not carefully designed and calibrated, but are simple orifices or tubes that get pointed in the direction that you are flying. The forward movement of the aircraft causes air to dam inside the pitot tube. This increases the pressure inside the tube.

Suitable pitot tubes can be made from a short piece of hollow aluminum or copper piping. Length and diameter are not important. Ensure that the front of the pitot tube has a suitable chamfer if you use thick walled tubing or you may introduce a speed reading error if you have a faster aircraft.

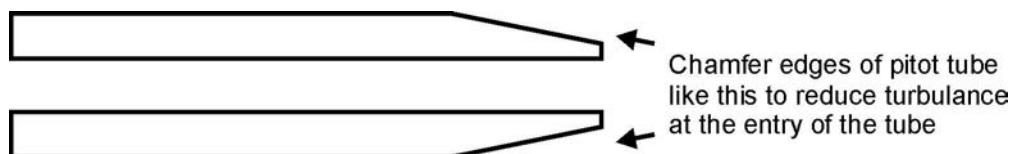

Example cross-section of thick walled pitot tube.

Suitable connection hose for both pitot tube and static port can be obtained from a hardware store or even a pet shop. Good quality tubing is often used for fish tanks and it has just the right diameter. Please note that this kind of tubing is not advised for pressurized aircraft. In this case you would need to obtain aircraft grade tubing of suitable diameter. The XTreme allows you to calibrate the airspeed reading. The main reason for this is to be able to remove errors introduced due to the airflow around your aircraft which may have an effect of your pitot tube pressure.

The pitot tube port is terminated in a female 1/8" NPT fitting, you will be required to use a standard 1/8" NPT male fitting.

10.3 XTreme General Connection Diagram

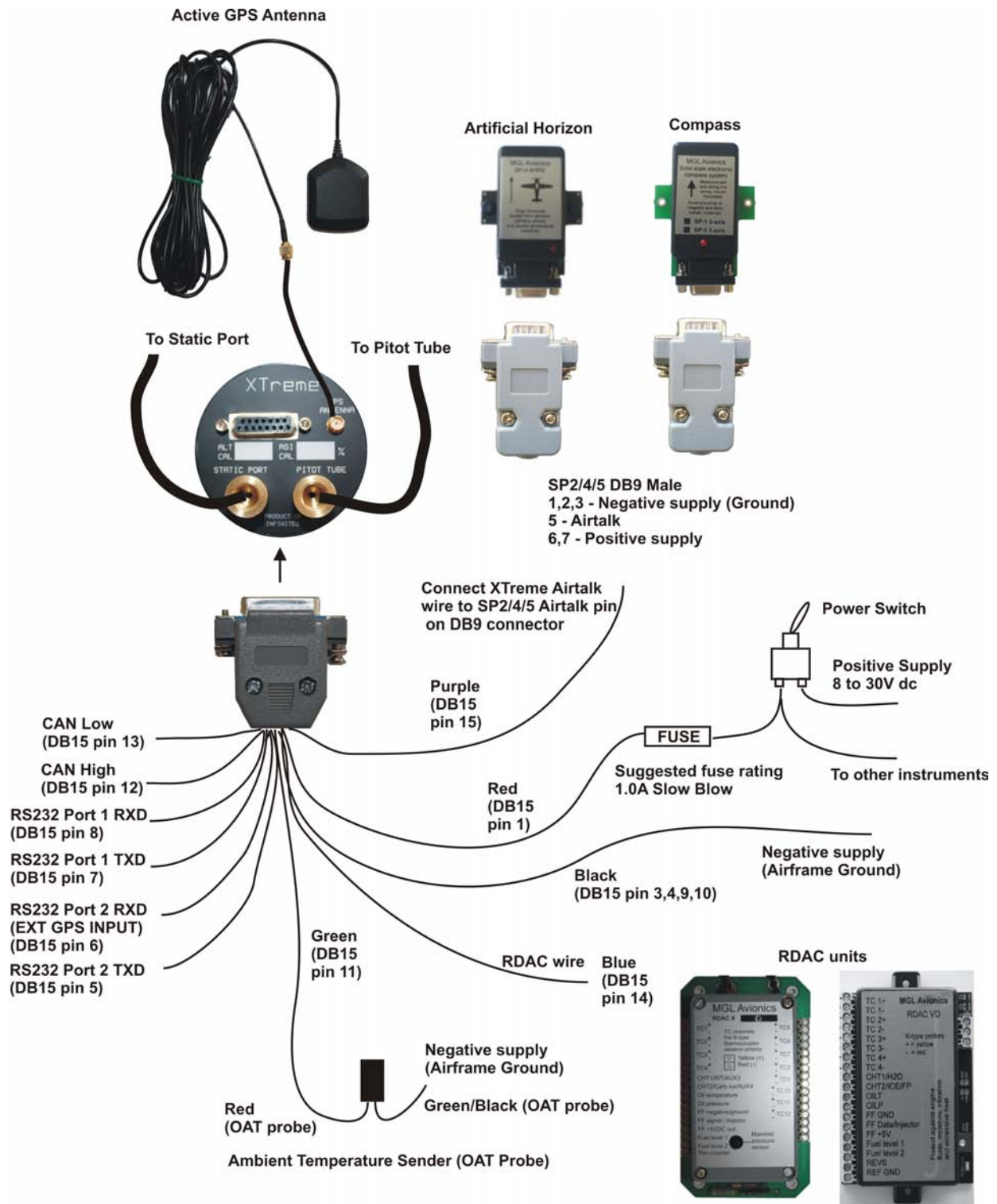

The use of an external 1A fuse is recommended. Connect the supply terminals to your aircrafts power supply. The XTreme can be used on both 12V and 24V without the use of any pre-regulators. Ensure that the supply voltage will not drop below 8V during operation as this may result in incorrect readings.

Please see MGL Avionics SP2,SP4/SP5/SP6/SP7 and RDAC documentation for installation and usage.

10.4 XTreme DB15 Cable connections

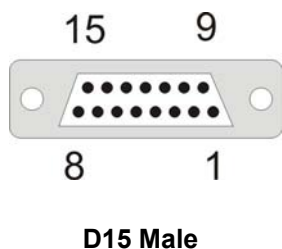

DB 15 Pin	Color	Function
1	Red	8-30Vdc power
2	White	Alarm Output
3,4,9,10	Black	Ground
5	NC	RS232 Port 2 Transmit
6	NC	RS232 Port 2 Receive
7	NC	RS232 Port 1 Transmit
8	NC	RS232 Port 1 Receive
11	Green	OAT Probe
12	NC	CAN High
13	NC	CAN Low
14	Blue	RDAC Signal
15	Purple	Airtalk (SP2/SP4 connection)

NC=Not Connected

The XTreme has a D15 Female connector. The connecting cable must have a D15 male connector attached to it.

11 Firmware upgrades

The XTreme's firmware can be upgraded in the field to the latest version via the SD card. This will keep your XTreme up to date with bug fixes and new features.

The name of the firmware file must be called XTREME.FW and it must reside in the root directory of the SD card. When the XTreme powers up it will first look at the SD card to see whether the file exists, if it does then it will prompt the user to upgrade the firmware. Use the soft keys at the bottom to select whether to upgrade to the new firmware or to exit the firmware upgrade feature. The XTreme also provides a soft key to delete the XTREME.FW file from the SD card to avoid removing the SD card and deleting it with a PC.

If the file does not exist, then the firmware upgrade function is bypassed and the XTremes main program is executed. Please check <http://www.mglavionics.co.za/XTreme.html> regularly for the latest firmware releases.



12 XTreme dimensions

12.1 Front view

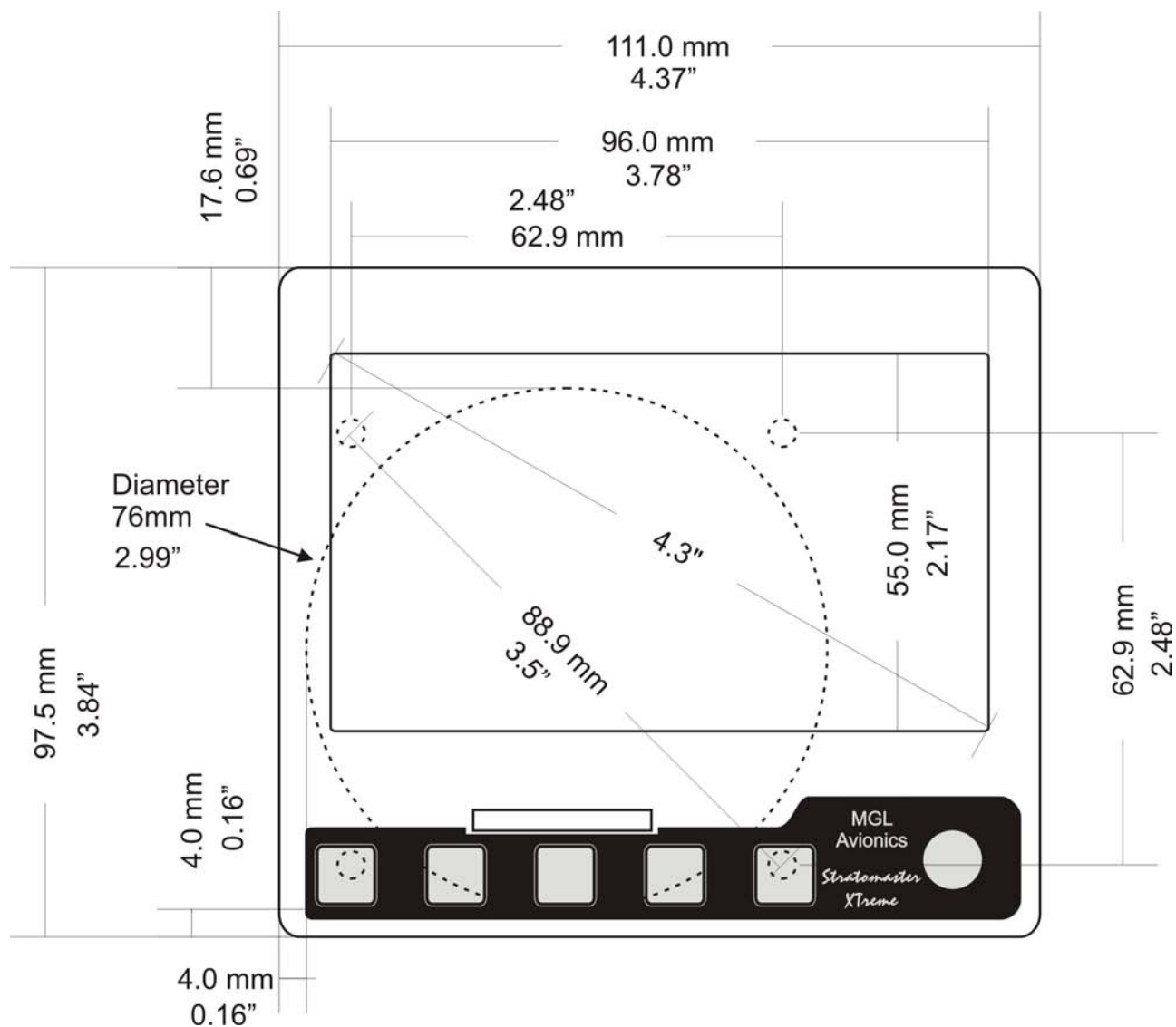

12.2 Side view

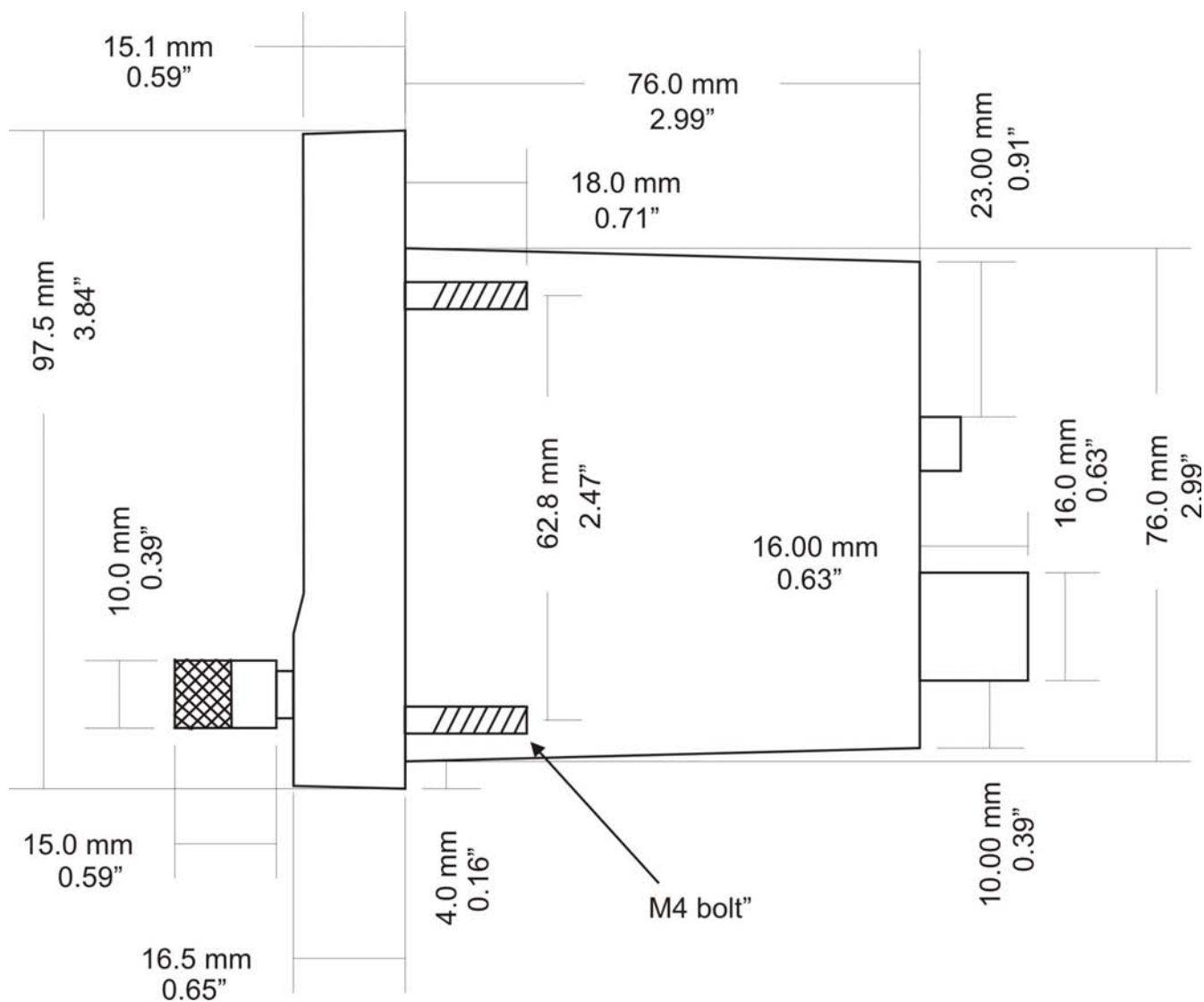

12.3 Top view

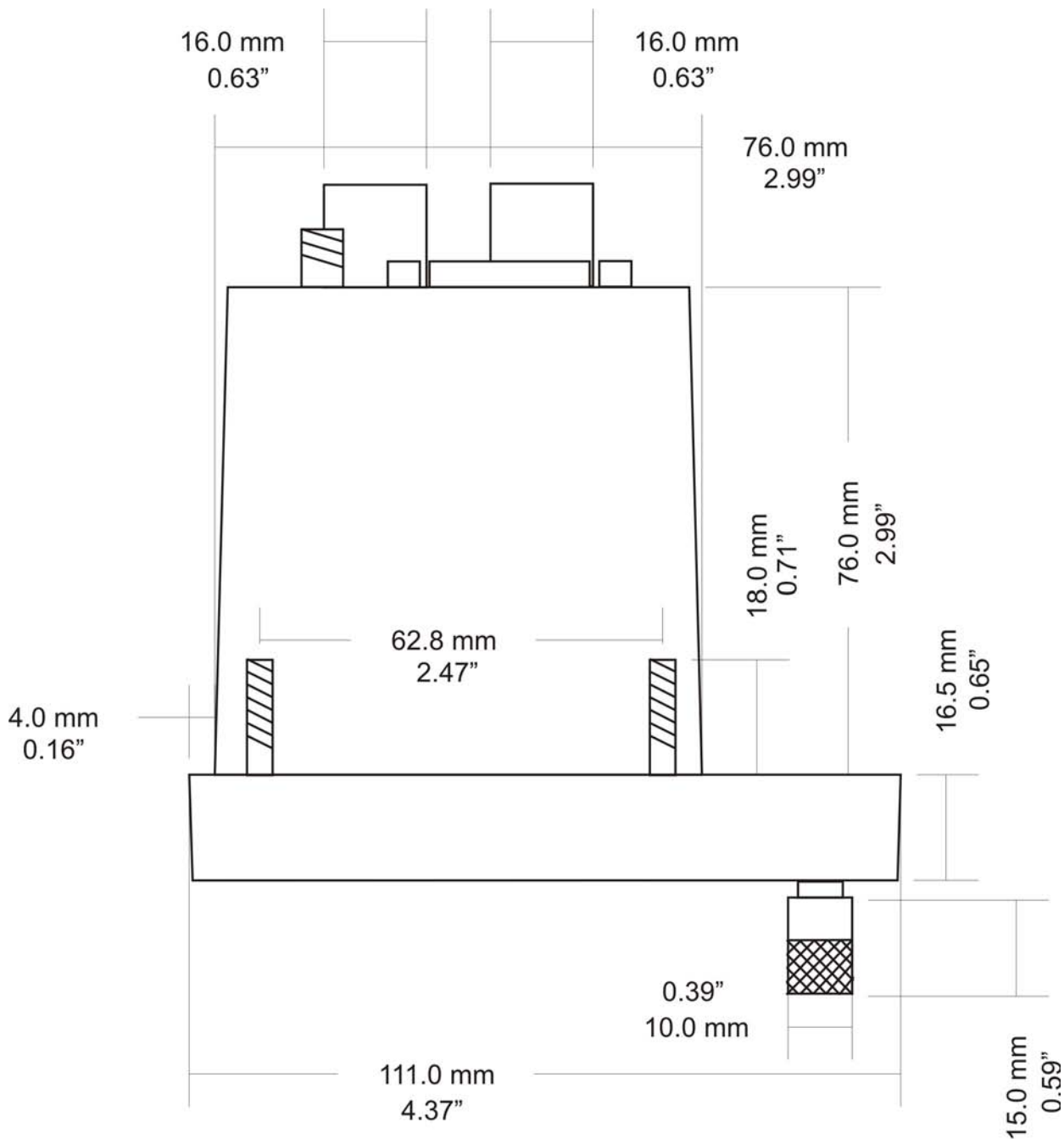

13 Warranty

This product carries a warranty for a period of one year from date of purchase against faulty workmanship or defective materials, provided there is no evidence that the unit has been mishandled or misused. Warranty is limited to the replacement of faulty components and includes the cost of labor. **Shipping costs are for the account of the purchaser.**

Note: Product warranty excludes damages caused by unprotected, unsuitable or incorrectly wired electrical supplies and or sensors, and damage caused by inductive loads.

14 Disclaimer

Operation of this instrument is the sole responsibility of the purchaser of the unit. The user must make themselves familiar with the operation of this instrument and the effect of any possible failure or malfunction.

This instrument is not certified by the FAA. Fitting of this instrument to certified aircraft is subject to the rules and conditions pertaining to such in your country. Please check with your local aviation authorities if in doubt. This instrument is intended for ultralight, microlight, homebuilt and experimental aircraft. Operation of this instrument is the sole responsibility of the pilot in command (PIC) of the aircraft. This person must be proficient and carry a valid and relevant pilot's license. This person has to make themselves familiar with the operation of this instrument and the effect of any possible failure or malfunction. Under no circumstances does the manufacturer condone usage of this instrument for IFR flights.

The manufacturer reserves the right to alter any specification without notice.