

MGL Avionics

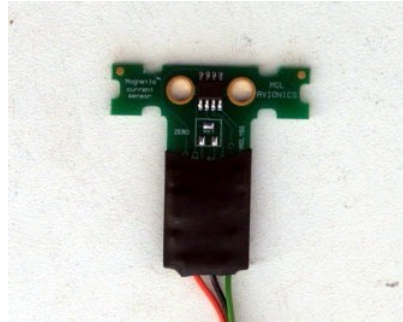

Magnetic current sensor

For aircraft systems supply circuit current measurement

Table of Contents

General.....	3
Installation.....	3
Principle of operation.....	4
What's inside ?.....	4
Example configurations.....	5
Low range current measurement.....	5
Medium/Low range current measurement	5
Medium range current measurement.....	6
High current measurement range.....	6
Very high current measurement range.....	7
Typical installation wiring.....	8
Additional precautions:.....	8
Direction of current for monitoring.....	8
EFIS configuration.....	10
Specifications:.....	12

General

The magnetic current sensor component is used to measure DC currents in aircraft power supply systems.

This device measures the strength of the magnetic field created around a wire carrying an electric current and uses this to determine the amount of current flowing in the conductor.

Compared to traditional methods this method has the following advantages:

- a) Simple to apply
- b) Complete electrical isolation from the current being measured
- c) Current can be measured in any conductor, regardless of electrical potential relative to the measuring system.
- d) No need to cut the conductor to insert a current measuring shunt and introduce a possible point of failure.

Current measurement can be performed over a large range with good range scaling abilities. Currents can be measured bi-directional (for example battery charge/discharge).

Installation

Depending on the desired current measurement range, the sensor is either fitted onto the conductor using cable ties or the conductor is folded or wrapped around the sensor one or more times.

Three wires need to be connected:

Red wire – This is connected to the positive power supply (avionics bus or EFIS secured supply output). Typical voltages are 12V or 24V.

Black wire – This wire must be connected to the measuring device's reference ground. In case a RDAC is used, connect this to the reference ground terminal of the RDAC. Do not connect this wire to any other ground path as this will introduce measurement errors.

Green wire – This is the signal that reflects the strength and direction of the magnetic field being measured. It is 2.5V with no field and moves towards a maximum of about 4.5V or a minimum of about 0.5V depending on the strength and direction of the magnetic field.

The Green wire can be connected to the RDAC inputs marked CHT1, CHT2, Oil pressure or Oil temperature. The input chosen needs to be setup in the EFIS so the EFIS knows which signal to use.

Further EFIS based calibrations are required:

- a) Set sensor zero. Measure the exact “zero current” voltage output for future reference. This needs to be done for every sensor installation. This can normally be done with the sensor removed from the conductor to be measured.
- b) Set sensor gain. In order to measure accurately it is required that the EFIS knows the relationship between measured magnetic field strength and conductor current. This depends on your installation. See the examples in this document.

Principle of operation

The electrical current in the conductor produces a magnetic field. The strength of the field is proportional to the strength of the electrical current.

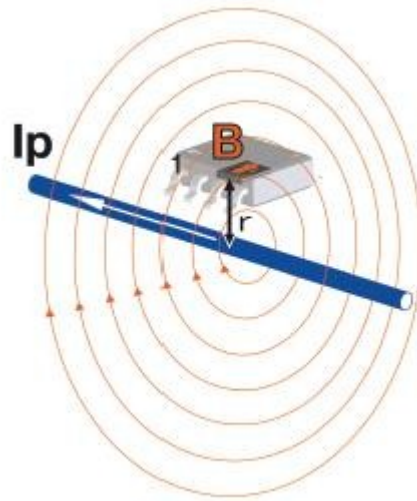

The magnetic sensor chip contains a hall effect sensor array placed on a magnetic flux concentrator. Tiny changes in the magnetically influenced properties of the hall effect sensors are amplified and processed and made available to external circuits.

The strength of the magnetic field around the cable depends on the current and the distance from the conductor.

It is possible to wrap the conductor around the sensor. If this is done, each winding contributes to a strengthening of the field and this makes the sensor able to detect weaker electrical currents.

What's inside ?

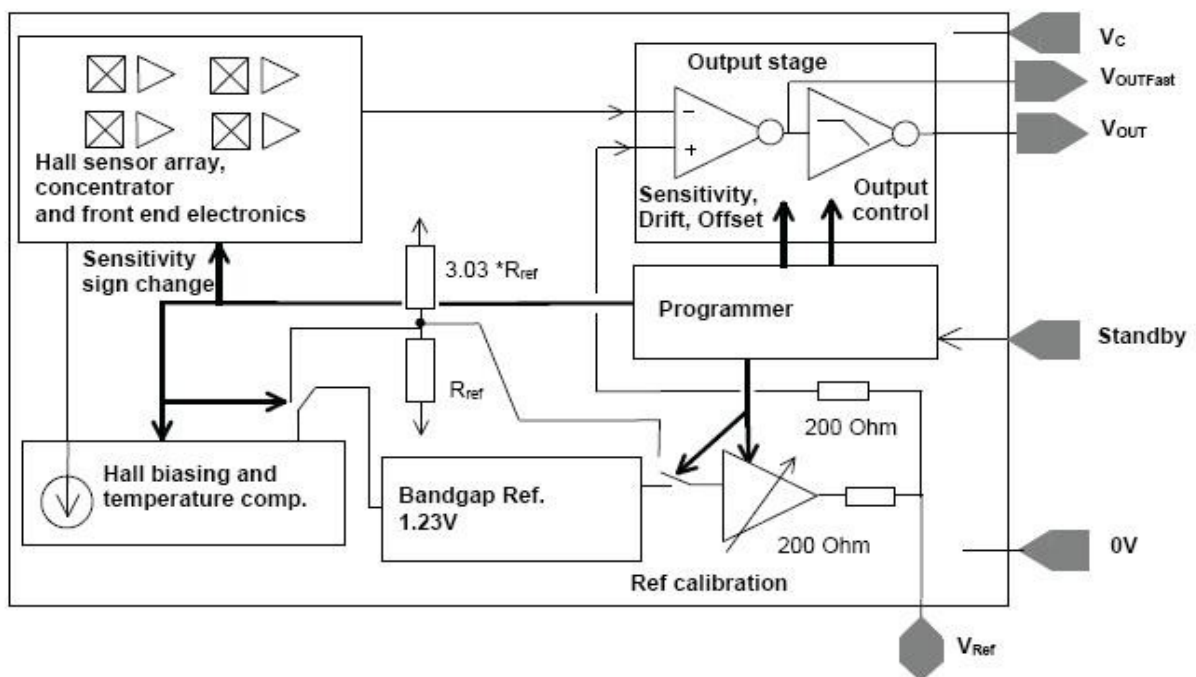

Example configurations

The following pages show example conductor configurations, EFIS gain calibration figures for these configurations and resultant measurement ranges.

Low range current measurement

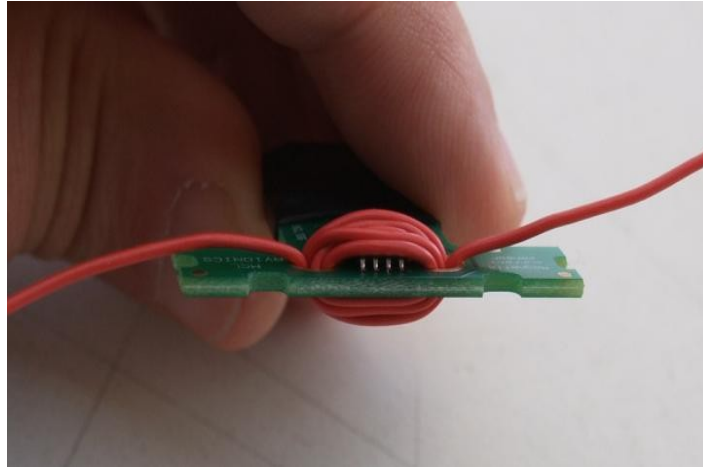

This configuration wraps 7.5 turns of AWG 25 (0.5mm) wire around the sensor. This results in a low range of about +/- 4A that is very resistant to stray magnetic interferences.

Gain calibration for the above configuration was found to be "22".

Medium/Low range current measurement

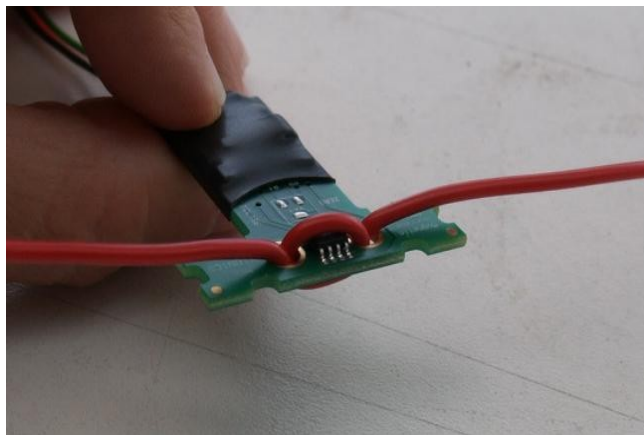

This variation uses 1.5 windings of AWG 18 (1.0mm) wire. This results in a measurement range of +/-12A with good resistance to external magnetic interference.

Gain calibration for this configuration is "85".

Medium range current measurement

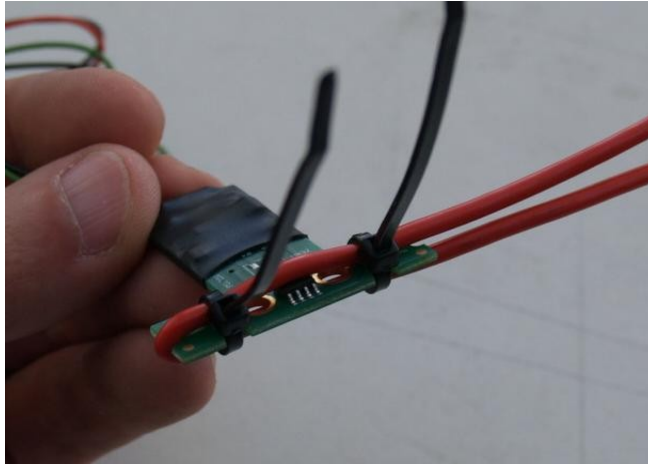

This variation folds a AWG14 (1.6mm) wire over the sensor (effectively one winding).

This results in a measurement range of +/-24A with reasonable resistance to stray magnetic interference.

Gain setting for this configuration was found to be 140.

High current measurement range

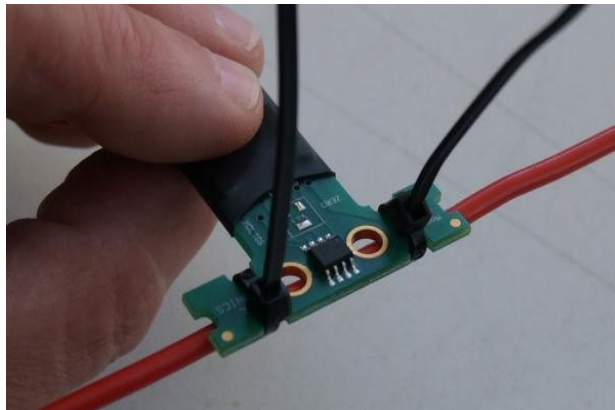

This configuration attaches the sensor onto a AWG 14 (1.6mm) wire.

The resultant current range is +/-50A.

Gain setting for this configuration was found to be 500.

This configuration uses a high gain setting and as result the effects of the Earth magnetic field can be seen depending on your aircraft's orientation. The effect is still relatively small considering the size of the overall current range and quite acceptable for most applications.

It is possible to enclose the above configuration in a ferromagnetic housing or wrapping to cancel out the effects of external disturbing fields if this is required.

Very high current measurement range

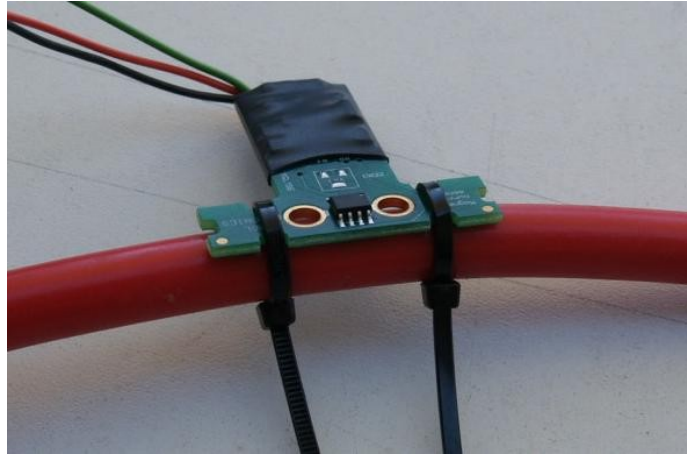

This configuration attaches the sensor to a high current cable such as used for an engine starter motor.

Using this configuration, currents as high as $\pm 120\text{A}$ can be measured. For this configuration a gain setting of 800 has been found to be accurate.

This configuration suffers from sensitivity towards external magnetic fields such as the Earth magnetic fields as well as effects due to sensor drift caused by temperature variations. Magnetic shielding can be employed to improve effects of stray external fields if required.

This configuration can show currents in excess of 1A due to external effects or sensor drift, however, it still remains a useful and simple to apply option for the measurement of very high currents.

Typical installation wiring

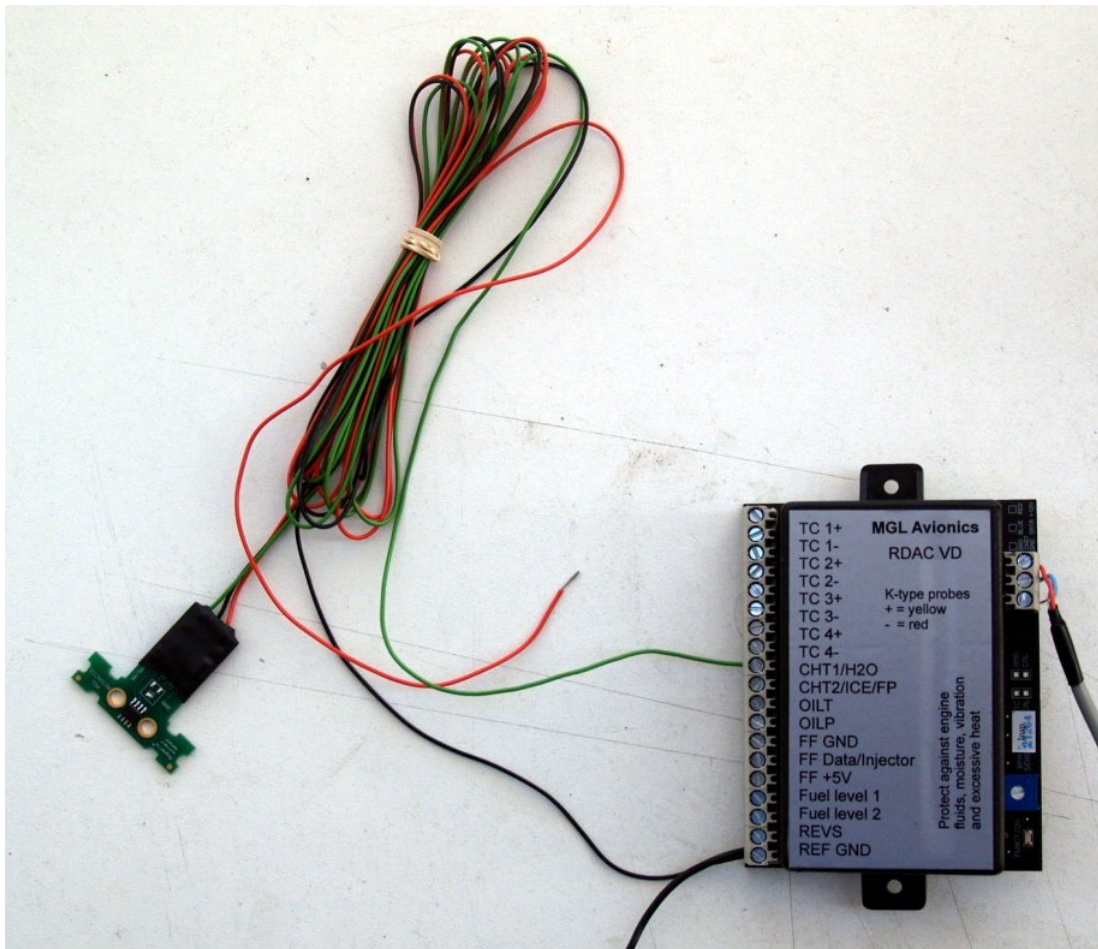

This image shows a typical installation in principle.

Here a RDAC VD is used and input CHT1 has been chosen (CHT1,CHT2,OILT and OILP are available options).

Note that the black wire (ground) from the sensor is wired to the RDAC reference ground and this must be wired to the engine block (or in case no engine monitoring is used, to the battery minus).

Failure to adhere to this ground wire principle can introduce significant measurement errors !

The red wire must be connected to the avionics bus positive power supply or EFIS secured output.

Additional precautions:

If it is possible that the sensor could be compromised by moisture or corrosive effects, it is permissible to coat the sensor with an oil based paint to protect the metal connections of the sensor IC.

Direction of current for monitoring

The current measurement sensor is designed to measure DC currents in either direction of current flow. In the EFIS the direction of current flow is shown as positive or negative

currents (+ or -) with numeric readouts and for graphic readouts left or down is negative and right or up is positive.

In order to display currents in the correct direction you need to ensure that the magnetic field created by the current in the conductor has the correct orientation.

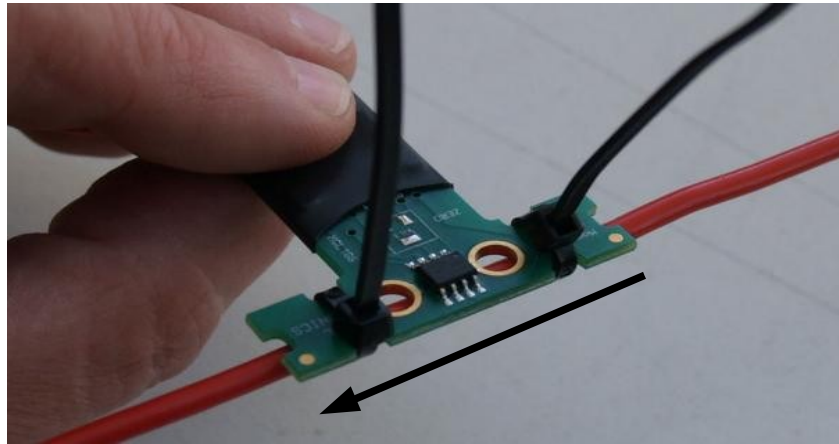

This image shows the direction of current required for a positive (+) reading. Please note that this image shows the wire BELOW the sensor. If the wire were ABOVE the sensor the reading would be negative (-) as the sensor chip would see the magnetic field from the reversed direction.

EFIS configuration

In order to be able to use the magnetic current sensor with an EFIS, the EFIS must be configured. If you would like to utilize graphic readouts or make use of more than one current sensor at the same time, you will need to modify existing screens using the Screen Designer in order to place the additional items.

The following example uses a Voyager or Odyssey G2, using two magnetic current sensors, numbers 1 and 2. These are connected to inputs CHT1 and CHT2 on the device RDAC 2.

The G2's native single current source is a shunt connected to an I/O Extender module. In this example we will not be using the shunt. The shunt is normally used for current sensor 1 but we will override this.

First, open the Voltage/Current setup menu in the System setup menu.

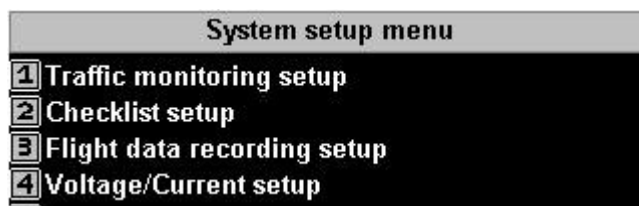

Now select "Setup magnetic current sensor 1"

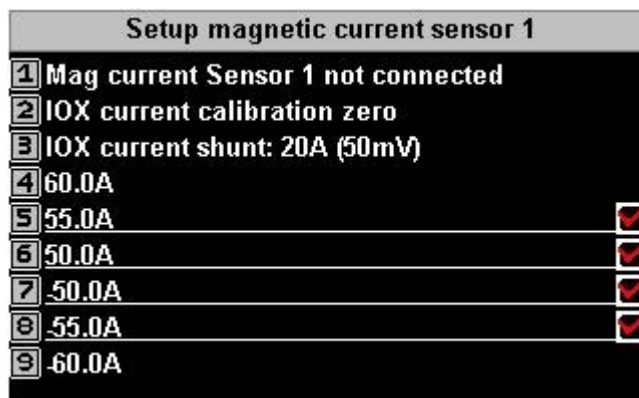
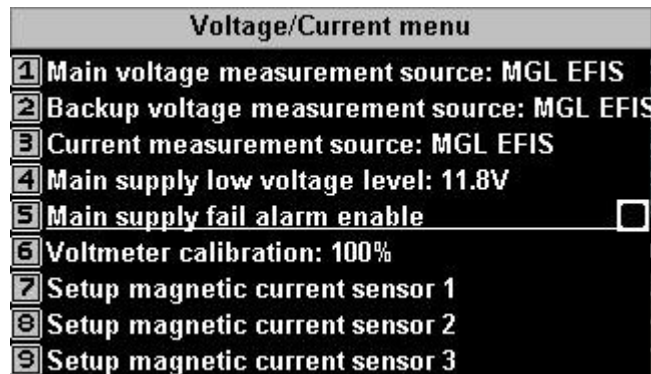

If no magnetic sensor 1 is selected, the G2 defaults to the IOX current shunt for current 1. The first thing we do is assign CHT1 on RDAC2 as source for current sensor 1.

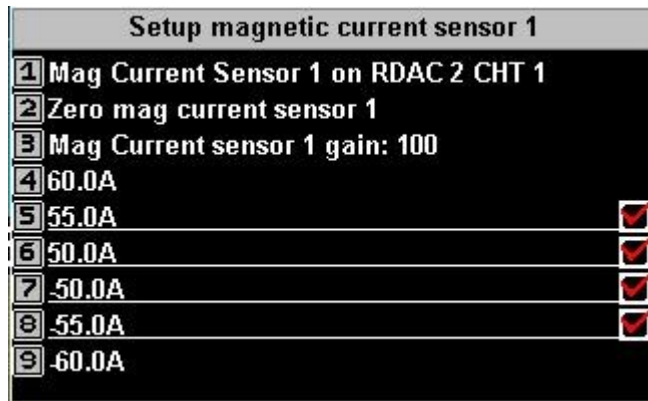

We now need to set the “zero current” measurement point for our magnetic current sensor. Ensure that either there is not current through the attached conductor or remove the sensor from the conductor and then select “Zero mag current sensor 1”. If you have a readout for the current on the screen at this time, you should now read 0.0A. Move the sensor around slightly to confirm that there are no stray interfering magnetic fields affecting the reading.

Note:

If you change the magnetic sensor, you should perform the zero procedure again as every sensor will have a slightly different zero current output voltage.

Now set an estimated sensor gain. You can use the gains from some of the examples. Smaller gain numbers mean bigger field per current unit, larger numbers mean smaller field per current unit.

If you have a DC current meter in series with your conductor, you can measure the actual current through your conductor and adjust the gain to match the reading of the meter exactly.

Set the 6 indicator points if you are planning to have a graphic readout. This sets the display limits (positive and negative) for your graphic readout and you can also enable red and yellow caution zones.

Repeat the above for your second current sensor on RDAC 2 CHT2:

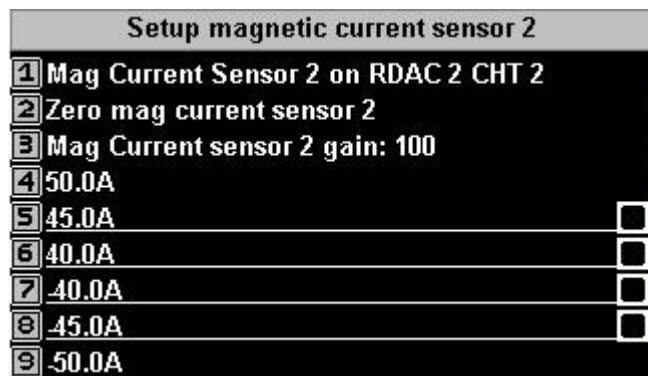

For this example we will place two graphic and numeric readouts on a screen.

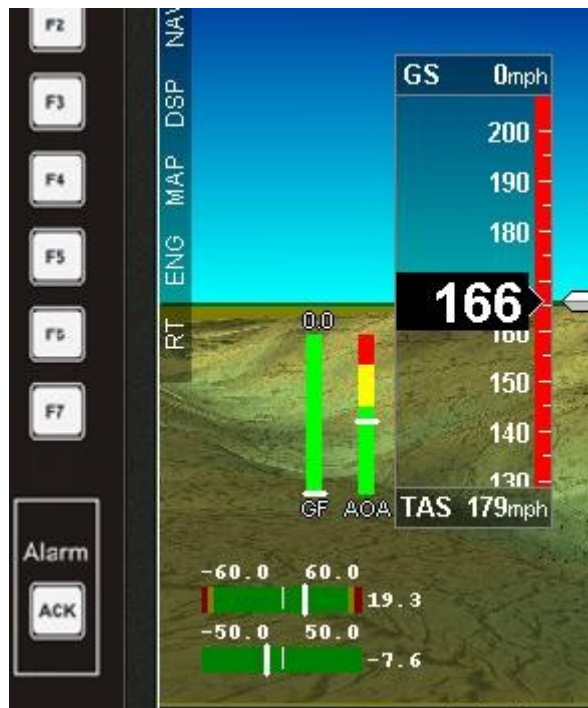

We assume you are familiar with the Screen designer. Here we placed two horizontal “bug bargraphs” on a screen and attached these to the two sensors. We used the built in numeric readouts. We could also have used “special text” items to display the numeric readouts in a different position if required.

Specifications:

This system is intended to measure DC currents and will not work with AC currents.

Operating voltage: 8V to 28V DC

Power source: DC, must be protected against over voltage. Unit is protected against reverse voltage.

Supply current: Less than 20mA.

Cable length: 1 meter (3 feet). May be extended. Signal wire (green) may be shielded in case of environment with large amounts of electrical interference.

Magnetic field strength range: +/- 3.3 mT

Magnetic sensitivity: 600mV/mT

Linearity error: +/- 0.4% over full range

Rated range of current measurements: up to +/-50A with over +/-100A achievable with some limitations caused mainly by the Earth magnetic field.

Variation of output voltage on temperature change: +/-0.00005% per degree Celsius typical over temperature range -40 to +100 degrees Celsius

Typical unshielded performance for various configurations:

<= 10A full scale range: Excellent

> 10A to <=30A full scale range: Good, some offset error may be introduced by nearby strong magnetic interferers. Choosing a good location should be part of application design.

> 30A to <=60A full scale range: Some minor effect on offset can be observed based on orientation to Earth magnetic field. Sensitivity to nearby magnetic interferers require good

placement of sensor to achieve maximum overall accuracy and performance with small currents.

> 60A full scale range: Definite effects due to Earth magnetic field should be evaluated. Relationship between magnetic field strength created by current through conductor at very low currents and Earth magnetic field is noticeable. Careful placement of sensor is required to achieve good overall performance with small currents.