

SECTION 2

CHAPTER 5

REPAIRING WIRE AND CABLE

INTRODUCTION

1. Aircraft wiring is sometimes damaged during normal operation and maintenance. This chapter provides information on repairing various types of wire and cable.

NOTE

Where practicable, damaged wire or cable should be replaced from one termination to the next.

SINGLE WIRE REPAIR

2. If an aircraft wire is damaged at a single point and there is sufficient slack in the wire, the damaged wire should be repaired with a single splice. If a wire is damaged along its length, the damaged segment must be cut out and replaced with a jumper wire and two splices (Figure 5-1).

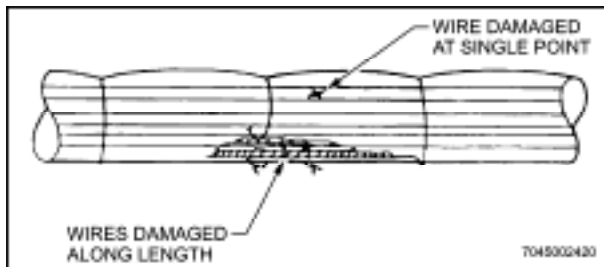

Figure 5-1 Damage Assessment

3. Carry out repairs as follows:
- Cut cable ties and remove cable clamps as required to access wire damage.
 - Work damaged wires to outside of wire bundle. Pull slack in wire toward damaged area to prevent strain on splice.
 - If more than one wire is to be spliced and wires are not colour coded or otherwise identified, tag wires before proceeding.

- Cut out the segment of wire with conductor or insulation damage. If a jumper wire is required, cut out at least 15cm of the damaged wire to allow room for splicing (Figure 5-2).

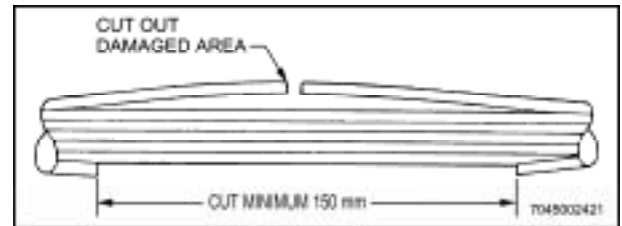

Figure 5-2 Removing Damaged Area

- If more than one jumper wire is to be installed, stagger splice positions by varying lengths of sections that are cut out of the damaged wires.
- Determine type and gauge of wire to be replaced from wire identification code or wiring diagram.
- Cut replacement wire 12.7mm longer than removed segment.
- From Table 5-1, select applicable splice for wire being replaced.

WARNING

DRY CLEANING SOLVENT P-D-680, TYPE II IS FLAMMABLE. AVOID EYE AND SKIN CONTACT OR BREATHING OF VAPOURS. APPROPRIATE PROTECTIVE EQUIPMENT IS REQUIRED.

- Clean 50mm of insulation, at wire ends to be spliced, with dry cleaning solvent.
- Strip wire insulation appropriate length for selected splice.
- Slide splice sealing sleeve over one end of stripped wire (Figure 5-3).

Table 5-1 Splice Selection

Wire Gauge	Splice Part Number	Colour Band	Crimp Tool	Crimp Die
26, 24, 22, 20	M81824/1-1	Red	M22520/5-01 or M22520/10-01	M22520/5-103 or M22520/10-104
20, 18, 16	M81824/1-2	Blue	M22520/5-01 or M22520/10-01	M22520/5-103 or M22520/10-104
16, 14, 12	M81824/1-3	Yellow	M22520/5-01 or M22520/10-01	M22520/5-102 or M22520/10-103

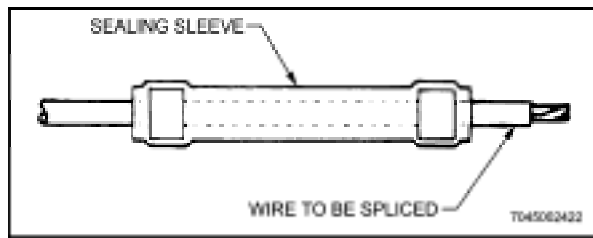

Figure 5-3 Sealing Sleeve placed on One Wire End

- i. Using appropriate crimping tool and die (Table 5-1) crimp splice to wire ends (Figure 5-4)

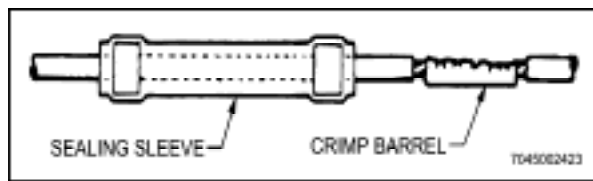

Figure 5-4 Correctly Installed Crimp Barrel

- m. Centre sealing sleeve over crimp barrel (Figure 5-5).

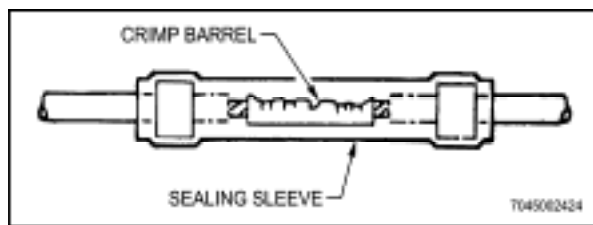

Figure 5-5 Sealing Sleeve Centred over Crimp Barrel

WARNING

USE ONLY HOT AIR GUN M83521/5-01 OR EQUIVALENT ON FUELLED AIRCRAFT

WARNING

USE OF NITROGEN WITH HOT AIR GUN M83521/5-01 IN AN ENCLOSED AREA CAN BE HAZARDOUS. ENSURE AREA IS WELL VENTILATED.

- n. Shrink sealing sleeve using hot air gun with small termination reflector. Shrink middle first and move heat towards one end until sealant melts and begins to flow out of sleeve (Figure 5-6). Repeat for other end. Allow to cool.

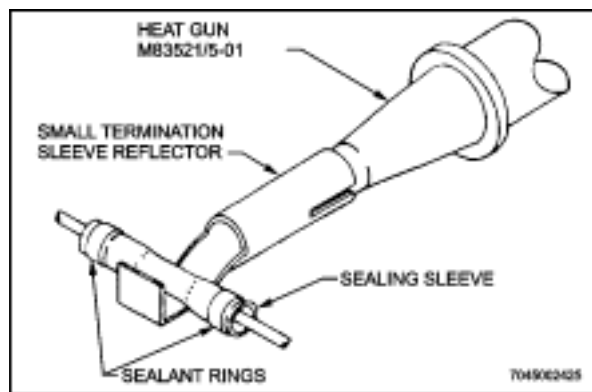

Figure 5-6 Splice Sealing

- o. If installing a jumper wire, repeat steps i to n.

- p. Work repaired wires into the bundle ensuring splices remain staggered (Figure 5-7).

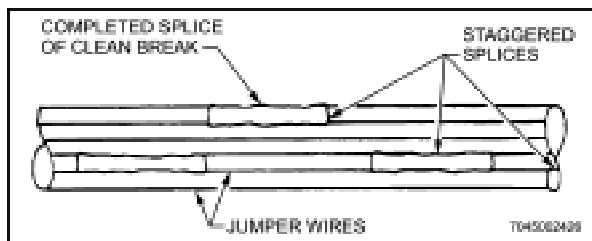

Figure 5-7 Completed Splices

- q. Replace cable clamps and cable ties removed for access.

MULTI-CONDUCTOR CABLE REPAIR

4. The following paragraphs provide details of procedures, components and tooling for the repair of multi-conductor cables.

NOTE

Where practicable, damaged cable should be replaced from one termination to the next.

5. **Unshielded Cable Repair.** Carry out repairs as follows:

- a. Cut cable ties and remove cable clamps as required to access cable damage.



WHEN SCORING CABLE JACKET, ENSURE CONDUCTOR INSULATION IS NOT DAMAGED.

- b. Using a sharp blade or knife, score cable jacket around the cable and along the length of the damaged area (Figure 5-8).
- c. Flex cable at score marks until jacket separates.
- d. Remove jacket to gain access to damaged wires (Figure 5-9).

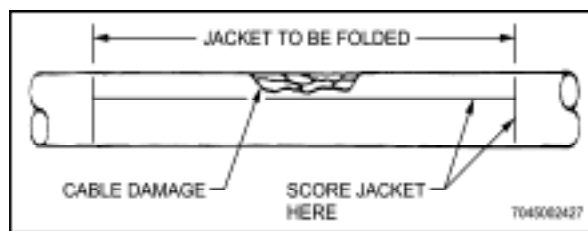

Figure 5-8 Scored Jacket on Multi-Conductor Cable

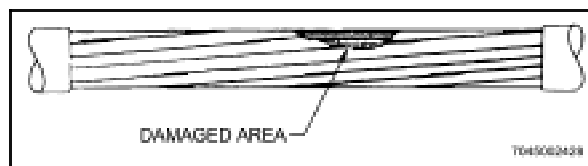

Figure 5-9 Damage Assessment

- e. If more than one wire is to be spliced and wires are not colour coded or otherwise identified, tag wires before proceeding.
- f. Cut out the segment of wire with conductor or insulation damage. If a jumper wire is required, cut out at least 15cm of the damaged wire to allow room for splicing (Figure 5-10).

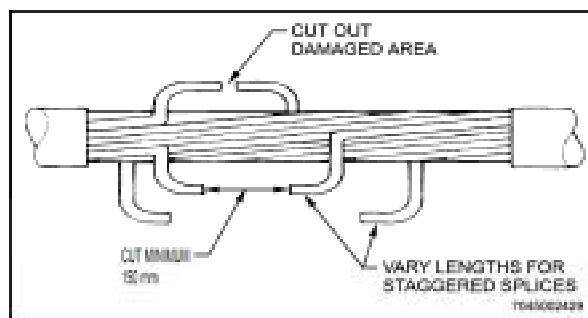

Figure 5-10 Removing Damaged Area

- g. If more than one jumper wire is to be installed, stagger splice positions by varying lengths of sections that are cut out of the damaged wires.
- h. Determine type and gauge of wire to be replaced from wire identification code or wiring diagram.
- i. Cut replacement wire 12.7 mm longer than removed segment.
- j. Select applicable splice for wire being replaced from Table 5-2.

Table 5-2 Splice Selection

Wire Gauge	Splice Part Number	Colour Band	Crimp Tool	Crimp Die
26, 24, 22, 20	M81824/1-1	Red	M22520/5-01 or M22520/10-01	M22520/5-103 or M22520/10-104
20, 18, 16	M81824/1-2	Blue	M22520/5-01 or M22520/10-01	M22520/5-103 or M22520/10-104
16, 14, 12	M81824/1-3	Yellow	M22520/5-01 or M22520/10-01	M22520/5-102 or M22520/10-103

WARNING

DRY CLEANING SOLVENT P-D-680, TYPE II IS FLAMMABLE. AVOID EYE AND SKIN CONTACT AND BREATHING OF VAPOURS. APPROPRIATE PROTECTIVE EQUIPMENT IS REQUIRED.

- k. Using dry cleaning solvent, clean 50 mm of insulation at wire ends to be spliced.
- l. Strip wire insulation appropriate length for selected splice.

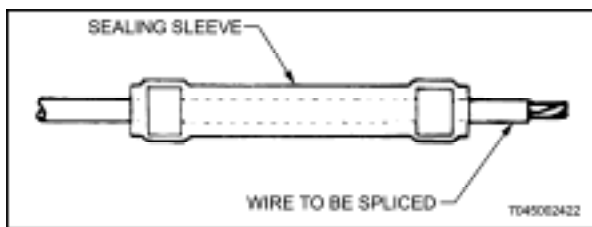

Figure 5-11 Sealing Sleeve Placed on One Wire End

- m. Slide splice sealing sleeve over one end of stripped wire (Figure 5-11).
- n. Using appropriate crimping tool and die (Table 5-2) crimp splice to wire ends (Figure 5-12).
- o. Centre sealing sleeve over crimp barrel (Figure 5-13).

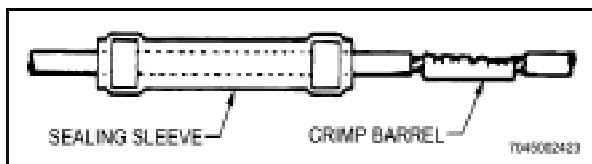

Figure 5-12 Correctly Installed Crimp Barrel

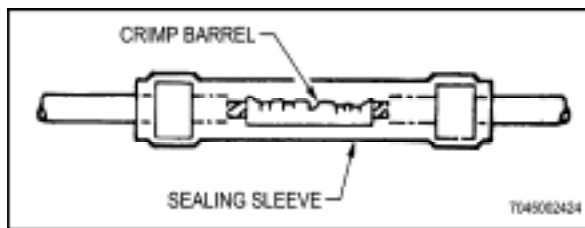

Figure 5-13 Sealing Sleeve Centred Over Crimp Barrel

WARNING

USE ONLY HOT AIR GUN M83521/5-01 OR EQUIVALENT ON FUELLED AIRCRAFT.

WARNING

USE OF NITROGEN WITH HOT AIR GUN M83521/5-01 IN AN ENCLOSED AREA CAN BE HAZARDOUS. ENSURE AREA IS WELL VENTILATED.

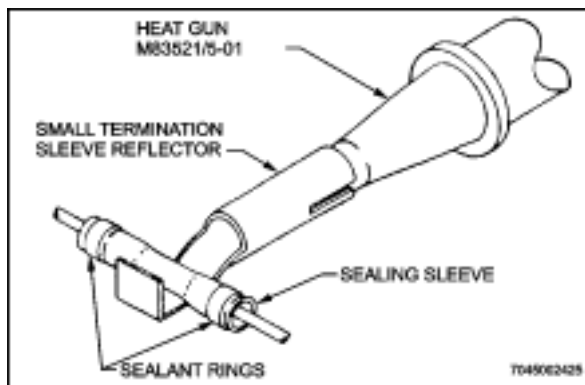

Figure 5-14 Splice Sealing

- p. Shrink sealing sleeve using hot air gun with small termination reflector. Shrink the middle first and heat towards one end until sealant melts and begins to flow out of sleeve (Figure 5-14).
- q. Repeat for other end. Allow to cool. If installing a jumper wire, repeat steps l. to p.

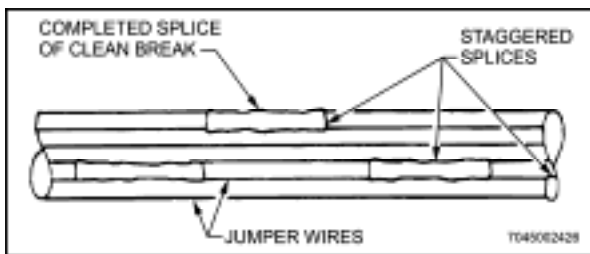

Figure 5-15 Completed Splices

- r. Work repaired wires into the bundle ensuring splices remain staggered (Figure 5-15).

NOTE

When applying insulating tape, hands should be free of dirt and oil.

- s. Apply insulating tape starting 12.7 mm before repaired area. Wrap tape one complete turn around cable parallel to jacket cut line (Figure 5-16).
- t. Keeping tape stretched firmly, begin wrapping around cable in a single layer, spiral wrap, using a 50% overlap.
- u. Continue wrapping until cable is wrapped 12.7 mm beyond repair area.
- v. Terminate tape by wrapping one complete turn around cable, keeping tape at a right angle to axis of bundle.
- w. Spot tie both ends of insulating tape (Figure 5-16).
- x. Replace cable clamps and cable ties removed for access.

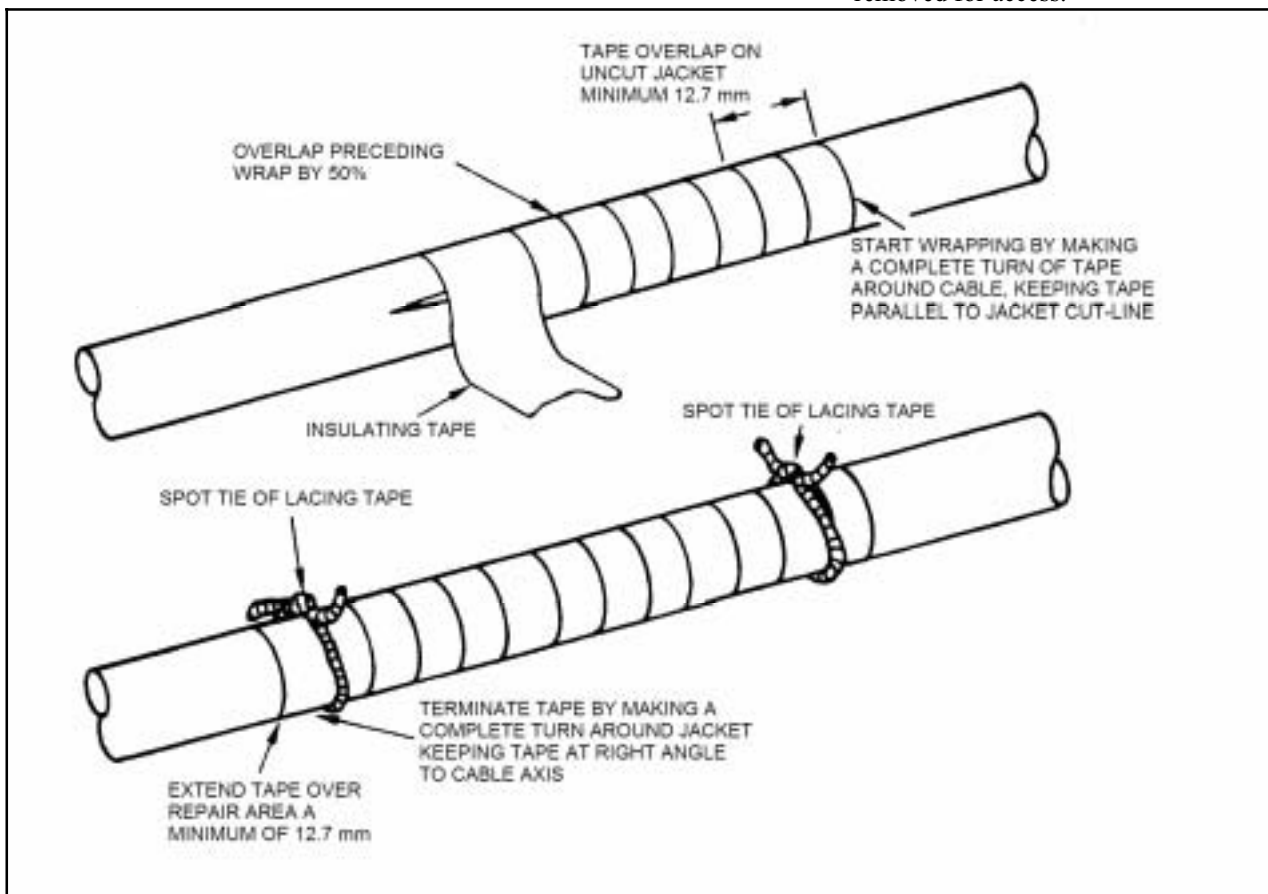

Figure 5-16 Taping Cable Jacket

- 6. **Shielded Cable Repair.** Carry out repairs as follows:

NOTE

This procedure calls for cutting all conductors in the cable to allow installation of the repair braid and insulation tubing.

- a. Cut cable ties and remove cable clamps as required to access cable damage.
- b. Select shield repair kit according to the outside diameter of the damaged cable jacket (Table 5-3).
- c. Using a sharp blade, score cable jacket around the cable and along the length of the damaged area (Figure 5-17).

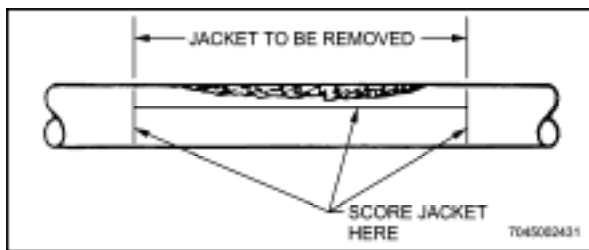

Figure 5-17 Scored Jacket

- d. Flex cable at score marks until jacket separates.
- e. Remove jacket.
- f. Using small scissors or diagonal cutter, remove shield, taking care not to damage underlying wire insulation (Figure 5-18).

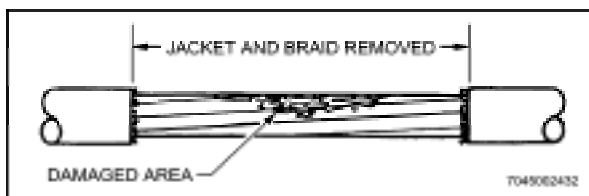

Figure 5-18 Damaged Multi-conductor Cable

- g. If wires are not colour coded or otherwise identified, tag all wires before proceeding.
- h. Cut wires to remove damage. If a segment of damaged wire must be cut out, remove at least 50 mm total length. (Figure 5-19). If damage is at a single point, damaged wire can be cut at the point of damage.

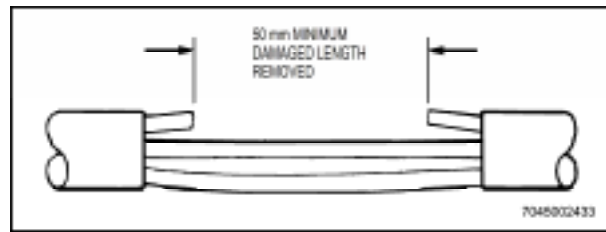

Figure 5-19 Wire With Damaged Section Removed

- i. Cut undamaged wires at staggered locations (Figure 5-20).

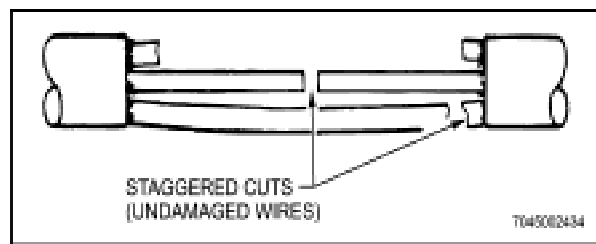

Figure 5-20 Undamaged Wires Cut at Staggered Locations

- j. Slide tubing and braid from shield repair kit, over one cable end (Figure 5-21). Tape tubing and braid away from repair area.

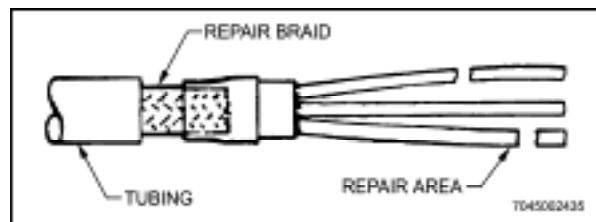

Figure 5-21 Tubing and Braid Located on Cable End

- k. If damaged sections of wire have been removed ensure that the removed sections are at least 50 mm long, to allow room for splicing.
- l. If more than one jumper wire is to be installed, stagger splice positions by varying lengths of sections that are cut out of the damaged wires.
- m. Determine type and gauge of wire to be replaced from cable identification code or wiring diagram.
- n. Cut replacement wire appropriate length to match removed segment (Figure 5-22).

Table 5-3 Shield Repair Kit Selection

Repair Kit	Cable Parameters		Kit Components		
Part Number	Number of Conductors	Conductor Size Range	Conductor Splice Part Number	Splice Quantity	Shield Splice Part Number
M81824/5-1 or D-150-0168	1	26-24-22-20	M81824/1-1	1	M81824/4-1
M81824/5-2 or D-150-0169	1	20-18-16	M81824/1-2	1	M81824/4-2
M81824/5-3 or D-150-0170	1	16-14-12	M81824/1-3	1	M81824/4-3
M81824/5-4 or D-150-0174	2	26-24-22-20	M81824/1-1	2	M81824/4-4
M81824/5-5 or D-150-0175	2	18-16	M81824/1-2	2	M81824/4-5
M81824/5-6 or D-150-0176	2	14	M81824/1-3	2	M81824/4-6
M81824/5-7 or D-150-0177	2	12	M81824/1-3	2	M81824/4-7
M81824/5-8 or D-150-0178	3 or 4	26-24	M81824/1-1	4	M81824/4-4
M81824/5-9 or D-150-0179	3 or 4	22-20	M81824/1-1	4	M81824/4-5
M81824/5-10 or D-150-0180	3 or 4	18-16	M81824/1-2	4	M81824/4-6
M81824/5-11 or D-150-0181	3 or 4	14-12	M81824/1-3	4	M81824/4-7

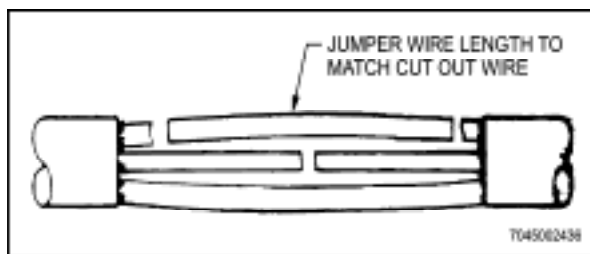

Figure 5-22 Jumper Wire Cut to Match Removed Segment

- o. Carry out wire splicing procedure as detailed in paragraph 3, steps i to n.
- p. When all wires have been reconnected, remove 12.7 mm of cable jacket at each end by carefully scoring around cable and along length to be stripped (Figure 5-17).

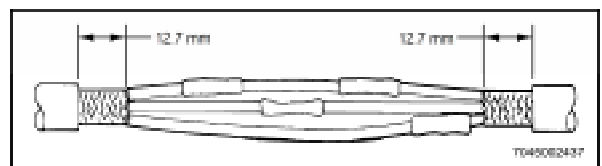

Figure 5-23 Jacket Removed

- q. Slide repair braid along cable and centre over repaired area (Figure 5-24).

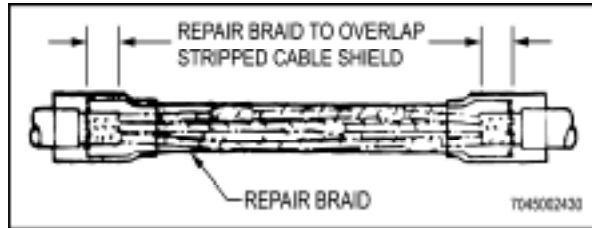

Figure 5-24 Repair Braid Centred Over Repair Area

WARNING

USE ONLY HOT AIR GUN M83521/5-01 OR EQUIVALENT ON FUELLED AIRCRAFT.

WARNING

USE OF NITROGEN WITH HOT AIR GUN M83521/5-01 IN AN ENCLOSED AREA CAN BE HAZARDOUS. ENSURE AREA IS WELL VENTILATED.

- r. Heat one end of the repair braid using hot air gun fitted with appropriate size reflector. Apply heat to the overlapping shield area until the solder melts and the sleeve shrinks onto the cable. Continue heating until solder flows into braid strands. Allow to cool undisturbed until solder solidifies (Figure 5-25).
- s. Repeat step r. for opposite end.
- t. Slide heat shrink tubing over repaired area and centre (Figure 5-26).
- u. Heat tubing using hot air gun fitted with appropriate size reflector. Start in the middle and heat until tubing shrinks moving out to one end. Repeat for other end.

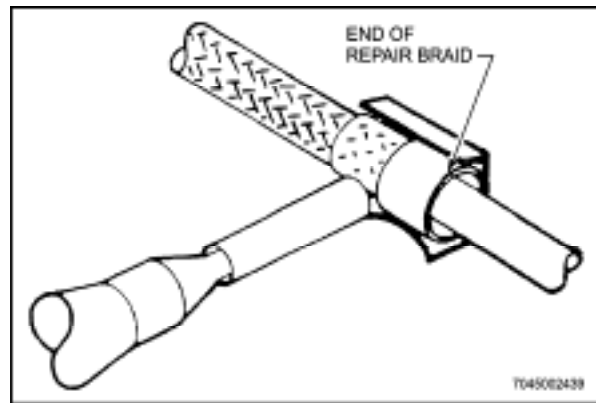

Figure 5-25 Heating Repair Braid

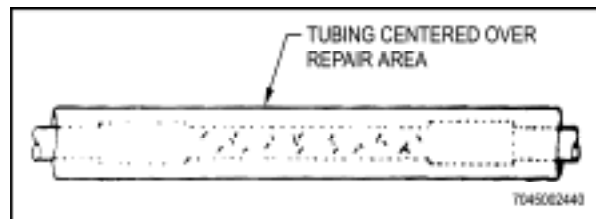

Figure 5-26 Tubing Centred Over Repaired Area

MIL-STD-1553 DATA BUS CABLE REPAIR

7. The following paragraphs provide general information on MIL-STD-1553 data bus system and the tooling, materials, and procedures for repair of the data bus.

8. The 1553B Data Bus is a computerized and multiplex digital data distribution system for the many functions of command, control, communications, and intelligence designed for military aircraft. A twinax cable of 78 ohms was selected to provide the transmitted digital information with the required protection from magnetic and electrostatic interference including nuclear electromagnetic pulse. Therefore, complete shielding of the pair along the transmission path as well as within the multi-pin connector must be maintained.

NOTE

While the information and procedures contained in this supplement are appropriate for repairing MIL-STD-1553 data bus cables, aircraft specific repair procedures take precedence.

Single Shield Cable with Solder Sleeve Primary Splice.

9. Prepare the cable using the following procedure:
- a. Remove 31mm of cable jacket (Figure 5-27).